



川源（中国）机械有限公司
GSD Industrial Co.,Ltd.



ZDB/HDB

轴、混流潜水电泵

ZDB/HDB submersible electric pump



ZDB/HDB 轴、混流潜水电泵

ZDB/HDB submersible electric pump

简介

ZDB型轴流潜水电泵和HDB型混流潜水电泵是传统的轴流泵和混流泵电动机机组的更新换代产品，驱动水泵的电动机是干式全封闭潜水三相异步电动机，该型潜水电泵可长期浸入水中运行，具有传统机组一系列无可比拟的优点。

- 由于电机与水泵构成一体，无须在安装现场进行耗工、耗时的电机、传动机构、水泵轴线对中的装配工序，现场安装方便、快速。
- 由于潜入水中运行，可以大大简化泵站的土工及建筑结构工程，减少安装面积，节约工程造价30%~40%。
- 噪声低，泵站内无高温，改善操作环境，可按要求建成全地下泵站，保持地面的环境风貌。
- 潜水电机采用双重或三重机械密封，F级（耐温155℃）绝缘，防护等级为IP68（IEC）。泵段采用全国统一设计的水力模型，可靠性高，且与传统水泵性能一致，便于用户选型。
- 操作方便，易于实现遥控和自动控制。
- 采用该型潜水电泵是解决水位涨落大的沿江、湖泊地区建泵站，解决电机防洪问题最彻底的办法，且省去了机泵间的长轴和中间轴承，使机组运行更为稳定可靠。

ZDB、HDB两型潜水电泵，可供农田排灌之用，也可用于工矿船坞、城市建设、供水工程、电站给排水之用。轴流潜水电泵适用于低扬程、大流量场合，混流潜水电泵效率高、汽蚀性能好，适用于水位变化较大及扬程要求较高的场合，输送介质为原水或轻度污水，其最高被输送液体温度40℃。

Introduction

The ZDB model axial-flow submersible electric pump and HDB model mixed-flow submersible electric pump are the upgraded and updated product of electrical motor set of conventional axial-flow pump and mixed-flow pump, the electric motor of hydraulic pump is an asynchronous motor of dry totally-enclosed submersible which can be operated in water for long-term with the advantages the conventional motor series can't match.

- Because the electric motor is combined with the hydraulic pump, the assembly procedure is no longer necessary for lining up axis of electric motor, transmission mechanism and hydraulic pump on site, which costs labor and time. Now the installation on-the-spot becomes easy and fast.
- Because of its operation submerged into water, the electric pump can greatly simplify geotechnical engineering and building structure engineering of pump station, reduce erection space and save 30%~40% construction cost.
- Low noise, no high temperature in pump station, improving the operational environment and underground pump station can be built according to the requirement, as a result, the environmental scene on the ground can be maintained.
- Submersible electric pump has double and triple mechanical seal and F grade insulation (155℃ thermostable) with protection grade IP68(IEC). The pump has hydraulic model of nationwide unified design, which has high reliability and has the same performance of the conventional hydraulic pump so that the customer can select the model easily.
- Convenient operation, and easy to realize remote control and automatic control.
- Adopting this type of submersible electric pump is the most thorough approach for building pump station along the river and lake area where the water level fluctuate greatly, as well as for resolving the problem of flood prevention of pump; moreover, the major shaft and intermediate shaft are not required any more, and the machine set can operate more steady and reliable.

The two models ZDB and HDB submersible electric pump can be used in irrigation and drainage of agricultural field, and can also be used in supply and sewerage water of factory, mine, dock, urban construction, water supply works and power station. The Axial-flow submersible electric pump applies to the condition of low-lift head, high flow-rate; while the mixed-flow submersible electric pump is very efficient with high performance of cavitation erosion. It is applicable for the occasion where the water level changes greatly and the requirement to the lift head is high. The conveyance medium is untreated water or lightly polluted water. The highest temperature of the conveyed liquid is 40℃.



型号说明 Type description

a. 500 Z D B - 70 J G T W

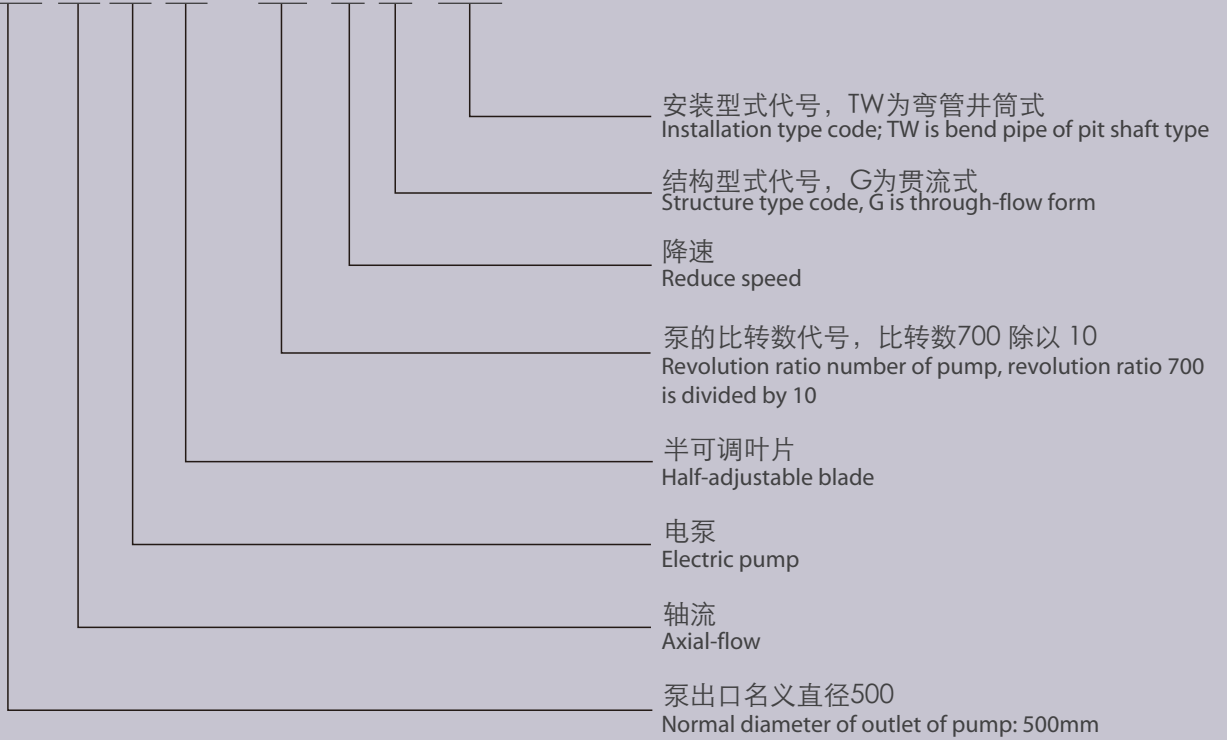

b. 700 H D B - 50 G T

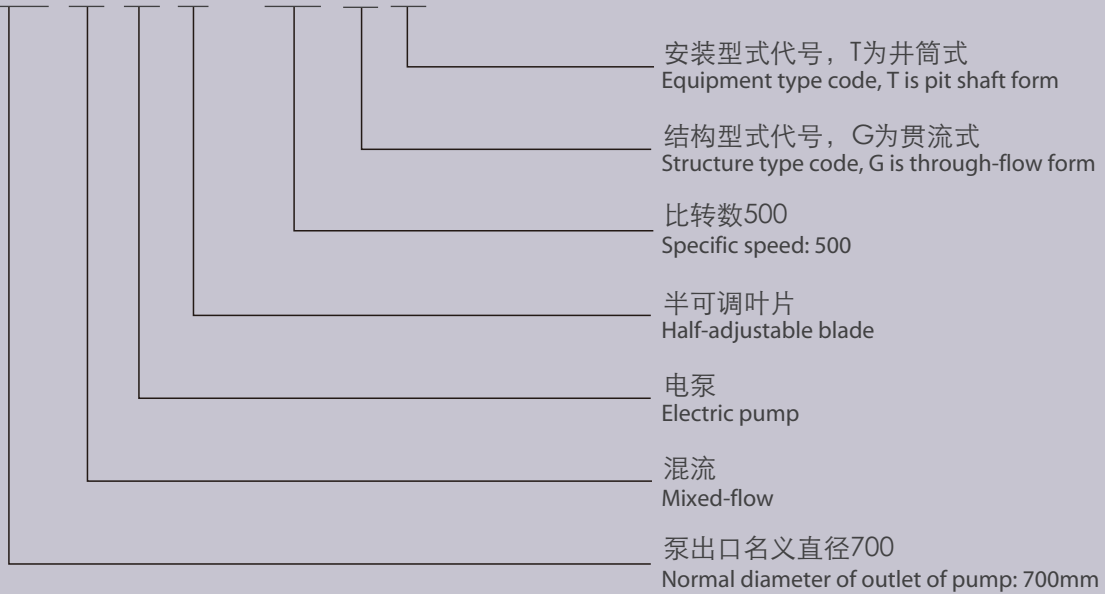

结构简图(ZDB型轴流潜水电泵) Structural diagram (ZDB model axial-flow submersible electric pump)

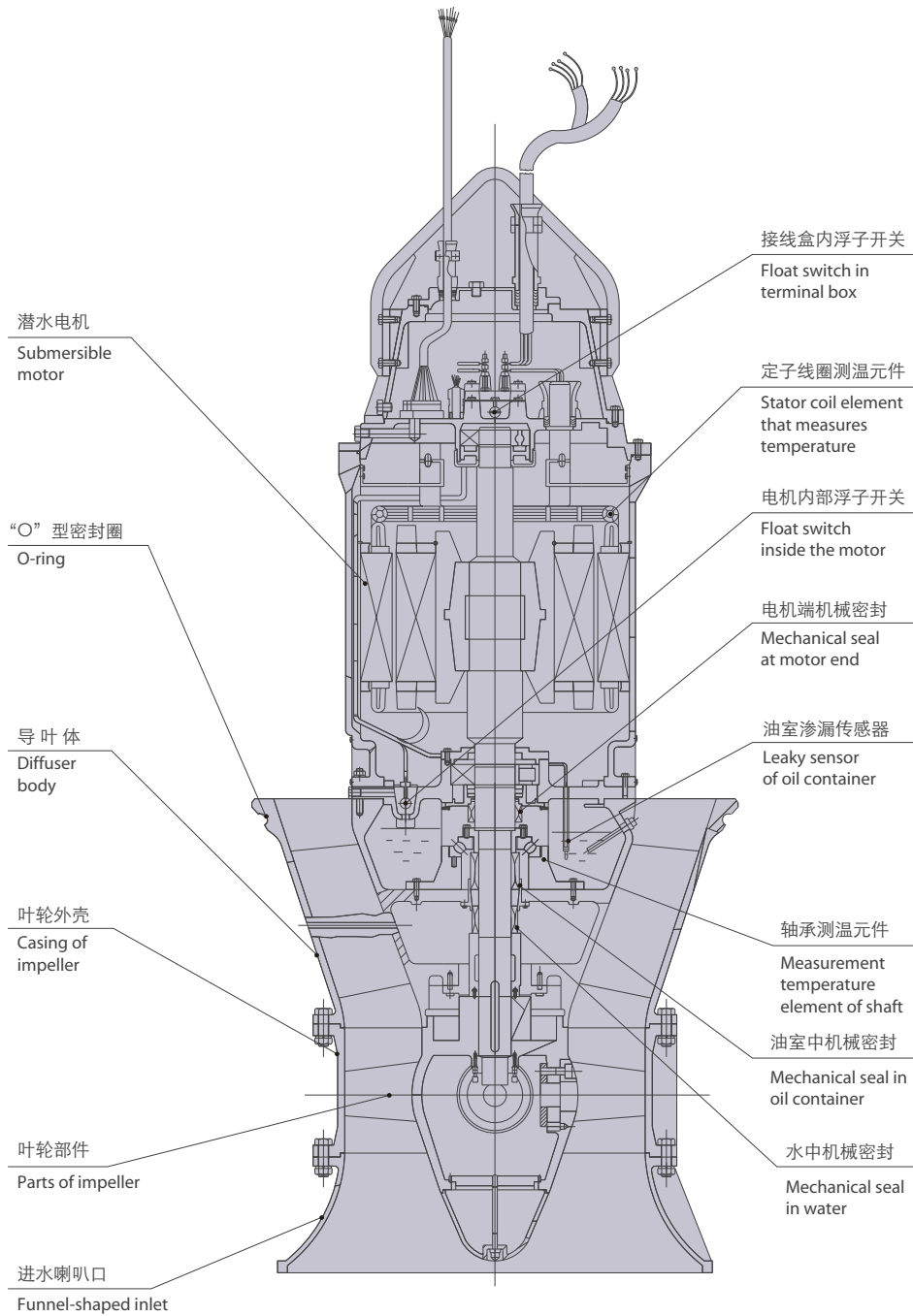

结构简图(HDB型潜水混流电泵) Structural diagram (HDB model mixed-flow submersible electric pump)

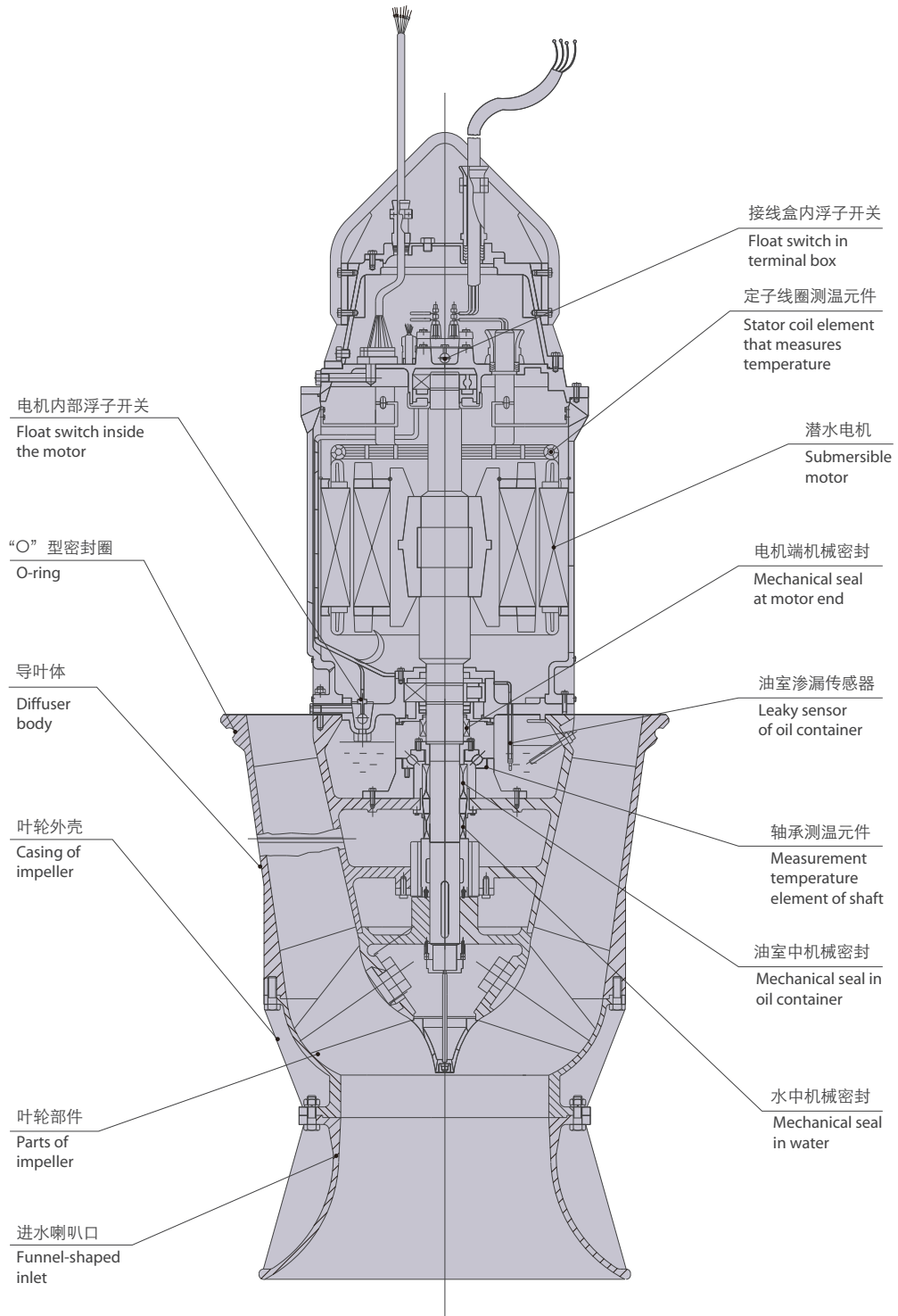

性能参数表及性能曲线

Performance parameter and Performance curve

300ZDB-50

叶片安装角度 Installation angle	流量 Capacity		扬程 Head (m)	转速 Speed (r/min)	功率 Power (kW)		效率 Eff. (%)	叶轮直径 D(mm) Impeller diameter			
	(m³/h)	(l/s)			轴功率 Shaft power	电机功率 Motor power					
-6°	426	118	7.46	1450	12.3	15	70.60	250			
	538	149	5.92		11.1		77.90				
	637	177	3.24		8.6		65.70				
-4°	439	122	7.81		13.2	15	70.60		250		
	584	162	6.11		12.3		79.10				
	692	192	3.18		9.1		65.70				
-2°	461	128	8.03		14.3	18.5	70.60			250	
	602	167	6.29		13.0		79.10				
	747	207	3.18		9.8		75.70				
0°	534	148	7.92		15.6	18.5	73.70				250
	669	186	6.32		14.5		79.30				
	806	224	3.33		11.1		65.70				
+2°	575	160	8.18	17.4	22	73.70	250				
	704	196	6.48	15.7		79.10					
	855	238	3.41	12.1		65.70					
+4°	602	167	8.33	18.5	22	73.70		250			
	740	206	6.66	17.0		79.10					
	888	247	3.70	13.6		65.70					

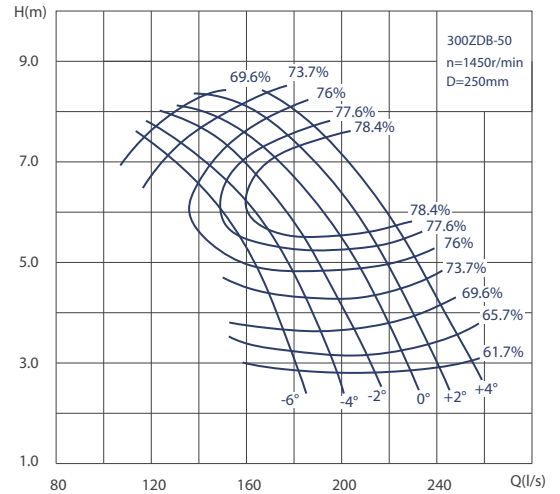

300ZDB-70

叶片安装角度 Installation angle	流量 Capacity		扬程 Head (m)	转速 Speed (r/min)	功率 Power (kW)		效率 Eff. (%)	叶轮直径 D(mm) Impeller diameter			
	(m³/h)	(l/s)			轴功率 Shaft power	电机功率 Motor power					
-6°	552	153	5.90	1450	11.9	15	74.90	250			
	667	185	4.58		10.3		80.90				
	750	208	2.60		6.9		76.90				
-4°	573	159	6.17		12.9	15	74.90		250		
	683	190	4.86		11.0		82.10				
	802	223	2.67		7.6		76.90				
-2°	585	163	6.25		13.3	18.5	74.90			250	
	719	200	5.07		12.1		82.30				
	844	234	2.78		8.3		76.90				
0°	600	167	6.46		14.1	18.5	74.90				250
	748	208	5.29		12.9		83.40				
	885	246	2.99		9.4		76.90				
+2°	606	168	6.53	14.4	18.5	74.90	250				
	767	213	5.35	13.3		83.80					
	917	255	3.13	10.2		76.90					
+4°	644	179	6.67	15.6	18.5	74.90		250			
	796	221	5.69	14.9		82.90					
	963	267	3.40	11.6		76.90					

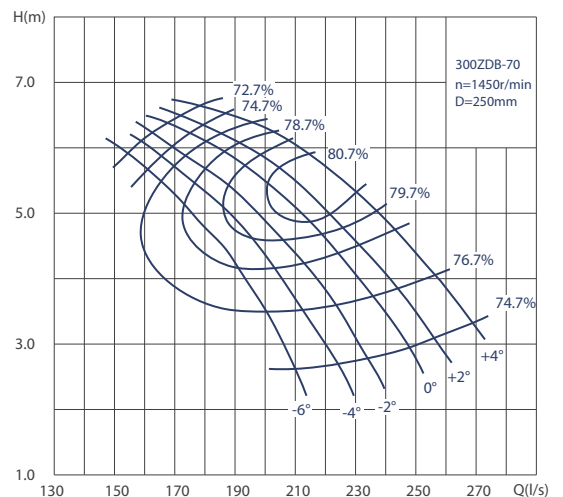

性能参数表及性能曲线

Performance parameter and Performance curve

300ZDB-85

叶片 安装 角度 Installation angle	流量 Capacity		扬程 Head (m)	转速 Speed (r/min)	功率 Power (kW)		效率 Eff. (%)	叶轮 直径 D(mm) Impeller diameter
	(m ³ /h)	(l/s)			轴功率 Shaft power	电机功率 Motor power		
-6°	365	101	4.97	1450	7.1	7.5	69.30	250
	517	144	2.94		5.3		78.30	
	565	157	1.94		4.3		69.30	
-4°	400	111	5.27		8.3	11	69.30	
	558	155	3.61		6.9		79.30	
	654	182	1.88		4.8		69.30	
-2°	440	122	5.52		9.5		69.30	
	635	177	3.54		7.7		79.30	
	736	204	1.94		5.6		69.30	
0°	484	134	5.73		10.9		69.30	
	696	193	3.67		8.7		80.30	
	792	220	2.12		6.6		69.30	
+2°	527	146	5.90	12.2	15	69.30		
	744	207	3.92	10.0		79.30		
	846	235	2.43	8.1		69.30		
+4°	575	160	5.89	13.3		69.30		
	760	211	4.44	11.7		78.30		
	900	250	2.73	9.7		69.30		

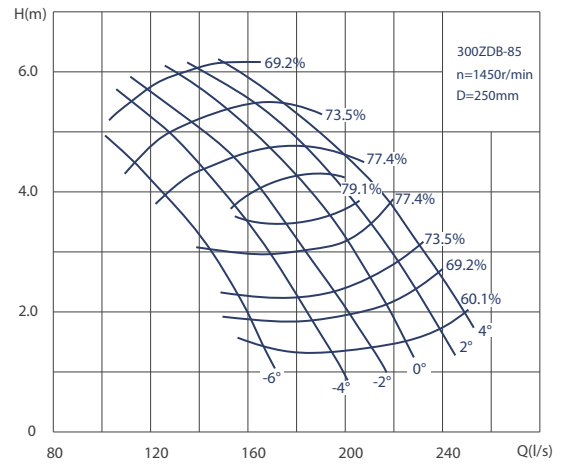

300ZDB-100

叶片 安装 角度 Installation angle	流量 Capacity		扬程 Head (m)	转速 Speed (r/min)	功率 Power (kW)		效率 Eff. (%)	叶轮 直径 D(mm) Impeller diameter
	(m ³ /h)	(l/s)			轴功率 Shaft power	电机功率 Motor power		
-6°	469	130	3.68	1450	6.1	7.5	76.70	250
	521	145	2.80		5.1		78.30	
	554	154	2.22		4.4		76.70	
-4°	509	142	3.99		7.2		76.70	
	583	162	2.85		5.7		79.80	
	633	176	2.03		4.6		76.70	
-2°	546	152	4.19		8.1		76.70	
	635	177	2.92		6.3		80.40	
	690	192	1.98		4.9		76.70	
0°	586	163	4.34		9.0	11	76.70	
	688	191	2.92		6.8		80.70	
	744	207	2.04		5.4		76.70	
+2°	633	176	4.35	9.8		76.70		
	729	203	3.08	7.5		81.20		
	792	220	2.20	6.2		76.70		
+4°	698	194	4.17	10.3	15	76.70		
	781	217	3.09	8.1		80.90		
	833	232	2.42	7.2		76.70		

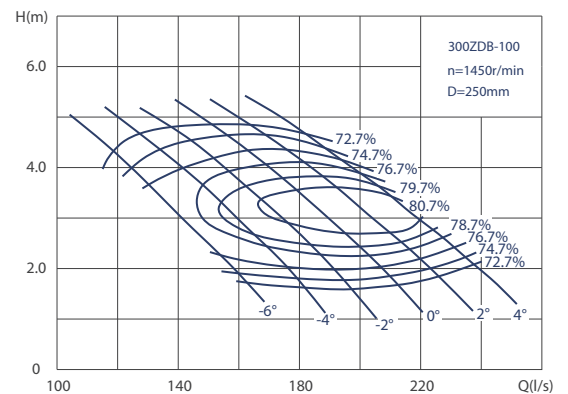

性能参数表及性能曲线

Performance parameter and Performance curve

350ZDB-50

叶片安装角度 Installation angle	流量 Capacity		扬程 Head (m)	转速 Speed (r/min)	功率 Power (kW)		效率 Eff. (%)	叶轮直径 D(mm) Impeller diameter
	(m³/h)	(l/s)			轴功率 Shaft power	电机功率 Motor power		
-4°	914	254	10.5	1450	33.27	37	78.58	300
	1033	287	8.82		30.79		80.60	
	1137	316	6.82		27.07		78.04	
-2°	972	270	10.6	1450	35.50	45	79.05	300
	1101	306	8.97		33.39		80.60	
	1213	337	6.94		29.36		78.09	
0°	1037	288	10.8	1450	38.30	45	79.64	300
	1177	327	9.08		36.12		80.60	
	1296	360	7.07		31.87		78.30	
+2°	1112	309	10.9	1450	41.30	45	79.96	300
	1253	348	9.20		38.94		80.60	
	1372	381	7.20		34.05		77.96	
+4°	1310	364	9.89	1450	44.06	45	80.10	300
	1346	374	9.35		42.54		80.60	
	1454	404	7.35		37.52		77.60	

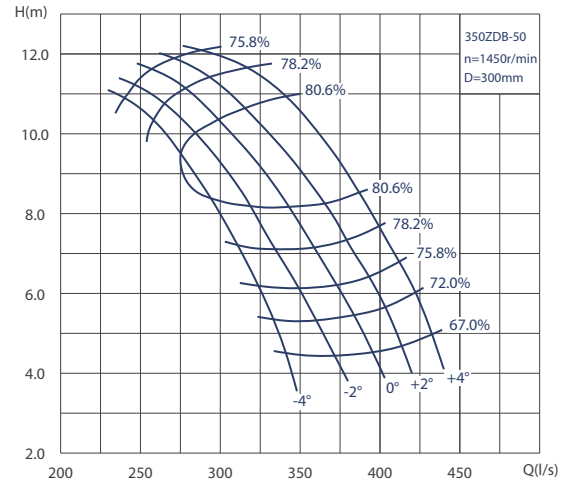

350ZDB-50J

叶片安装角度 Installation angle	流量 Capacity		扬程 Head (m)	转速 Speed (r/min)	功率 Power (kW)		效率 Eff. (%)	叶轮直径 D(mm) Impeller diameter
	(m³/h)	(l/s)			轴功率 Shaft power	电机功率 Motor power		
-4°	608	169	4.88	980	10.38	15	77.93	300
	673	187	4.34		9.87		80.59	
	706	196	3.97		9.46		80.60	
-2°	648	180	4.92	980	11.04	15	78.67	300
	716	199	4.39		10.63		80.60	
	752	209	4.02		10.22		80.60	
0°	698	194	4.97	980	11.90	15	79.44	300
	767	213	4.44		11.50		80.60	
	803	223	4.08		11.07		80.60	
+2°	749	208	5.02	980	12.81	15	79.94	300
	817	227	4.50		12.43		80.60	
	853	237	4.15		11.96		80.60	
+4°	814	226	5.10	980	14.09	15	80.21	300
	878	244	4.58		13.59		80.60	
	911	253	4.23		13.02		80.60	

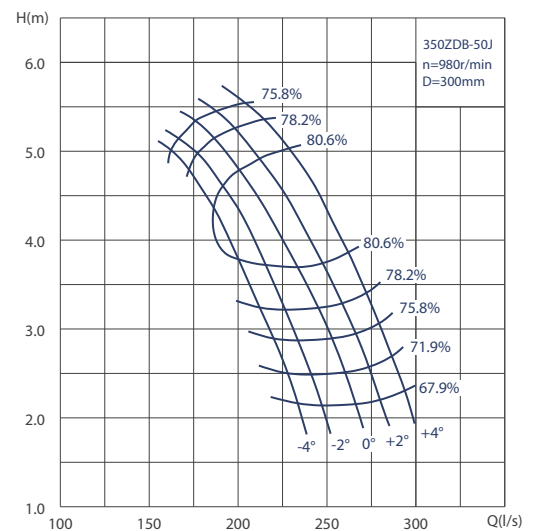

性能参数表及性能曲线

Performance parameter and Performance curve

350ZDB-70

叶片 安装 角度 Installation angle	流量 Capacity		扬程 Head (m)	转速 Speed (r/min)	功率 Power (kW)		效率 Eff. (%)	叶轮 直径 D(mm) Impeller diameter			
	(m³/h)	(l/s)			轴功率 Shaft power	电机功率 Motor power					
-6°	954	265	8.50	1450	29.1	37	76.00	300			
	1152	320	6.60		25.3		82.00				
	1296	360	3.75		17.0		78.00				
-4°	990	275	8.88		31.5	45	76.00		300		
	1181	328	7.00		27.1		83.20				
	1386	385	3.85		18.6		78.00				
-2°	1012	281	9.00		32.6	55	76.00			300	
	1242	345	7.30		29.6		83.40				
	1458	405	4.00		20.4		78.00				
0°	1037	288	9.20		34.6	55	76.00				300
	1292	359	7.62		31.8		84.50				
	1530	425	4.30		23.0		78.00				
+2°	1048	291	9.40	35.3	55	76.00	300				
	1325	368	7.70	32.7		84.90					
	1584	440	4.50	24.9		78.00					
+4°	1112	309	9.60	38.3	55	76.00		300			
	1375	382	8.20	36.6		84.00					
	1663	462	4.90	28.5		78.00					

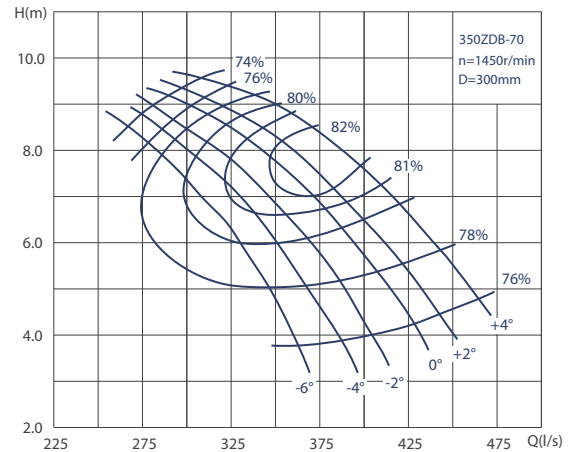

350ZDB-70J

叶片 安装 角度 Installation angle	流量 Capacity		扬程 Head (m)	转速 Speed (r/min)	功率 Power (kW)		效率 Eff. (%)	叶轮 直径 D(mm) Impeller diameter			
	(m³/h)	(l/s)			轴功率 Shaft power	电机功率 Motor power					
-6°	645	179	3.88	980	9.4	11	72.60	300			
	779	216	3.01		8.1		78.60				
	876	243	1.71		5.5		74.60				
-4°	669	186	4.06		10.2	11	72.60		300		
	798	222	3.20		8.7		79.80				
	937	260	1.76		6.0		74.60				
-2°	684	190	4.11		10.5	11	72.60			300	
	840	233	3.33		9.5		80.00				
	985	274	1.83		6.6		74.60				
0°	701	195	4.25		11.2	11	72.60				300
	873	243	3.48		10.2		81.10				
	1034	287	1.96		7.4		74.60				
+2°	708	197	4.29	11.4	15	72.60	300				
	895	249	3.52	10.5		81.50					
	1071	297	2.06	8.1		74.60					
+4°	752	209	4.39	12.4	15	72.60		300			
	930	258	3.75	11.8		80.60					
	1124	312	2.24	9.2		74.60					

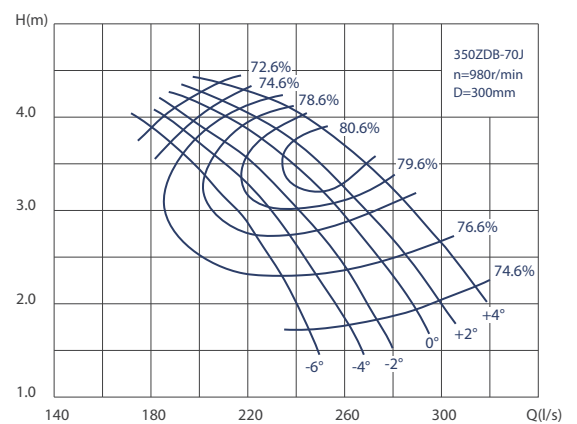

性能参数表及性能曲线

Performance parameter and Performance curve

350ZDB-85

叶片安装角度 Installation angle	流量 Capacity		扬程 Head (m)	转速 Speed (r/min)	功率 Power (kW)		效率 Eff. (%)	叶轮直径 D(mm) Impeller diameter
	(m³/h)	(l/s)			轴功率 Shaft power	电机功率 Motor power		
-4°	828	230	6.98	1450	20.8	30	75.79	300
	968	269	5.01		16.4		80.40	
	1094	304	2.64		11.2		70.3	
-2°	900	250	7.15	1450	23.3	30	75.30	300
	1048	291	5.22		18.5		80.40	
	1177	327	2.89		13.0		71.49	
0°	965	268	7.30	1450	25.9	37	74.05	300
	1116	310	5.41		20.5		80.40	
	1246	346	3.10		14.3		73.43	
+2°	1012	281	7.41	1450	27.2	37	75.06	300
	1184	329	5.61		22.5		80.40	
	1332	370	3.39		16.5		74.43	
+4°	1073	298	7.59	1450	29.2	37	75.89	300
	1274	354	5.84		25.2		80.40	
	1411	392	3.67		18.9		74.76	

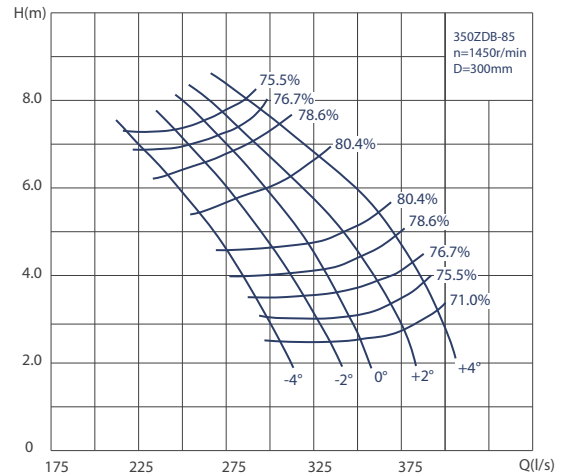

350ZDB-85J

叶片安装角度 Installation angle	流量 Capacity		扬程 Head (m)	转速 Speed (r/min)	功率 Power (kW)		效率 Eff. (%)	叶轮直径 D(mm) Impeller diameter
	(m³/h)	(l/s)			轴功率 Shaft power	电机功率 Motor power		
-4°	583	162	3.00	980	6.2	7.5	77.47	300
	644	179	2.41		5.3		80.40	
	713	198	1.55		4.0		75.15	
-2°	634	176	3.09	980	6.9	11	77.32	300
	695	193	2.51		5.9		80.40	
	770	214	1.66		4.5		76.85	
0°	677	188	3.17	980	7.5	11	76.52	300
	742	206	2.60		6.5		80.40	
	817	227	1.77		5.1		77.18	
+2°	709	197	3.23	980	8.1	11	77.34	300
	785	218	2.70		7.2		80.40	
	868	241	1.90		5.8		77.84	
+4°	756	210	3.33	980	8.8	11	78.06	300
	835	232	2.82		8.0		80.40	
	922	256	2.04		6.6		77.96	

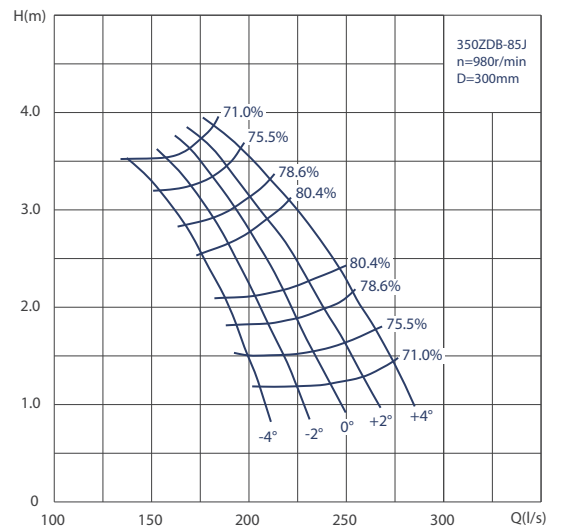

性能参数表及性能曲线

Performance parameter and Performance curve

350ZDB-100

叶片 安装 角度 Installation angle	流量 Capacity		扬程 Head (m)	转速 Speed (r/min)	功率 Power (kW)		效率 Eff. (%)	叶轮 直径 D(mm) Impeller diameter
	(m³/h)	(l/s)			轴功率 Shaft power	电机功率 Motor power		
-6°	810	225	5.30	1450	15.0	18.5	78.00	300
	900	250	4.03		12.4		79.60	
	958	266	3.20		10.7		78.00	
-4°	880	245	5.75		17.7	22	78.00	
	1008	280	4.10		13.9		81.10	
	1094	304	2.93		11.2		78.00	
-2°	943	262	6.03		19.9	30	78.00	
	1098	305	4.21		15.4		81.70	
	1192	331	2.85		11.9		78.00	
0°	1013	282	6.25		22.1	37	78.00	
	1188	330	4.20		16.6		82.00	
	1285	357	2.94		13.2		78.00	
+2°	1094	304	6.27	24.0	37	78.00		
	1260	350	4.43	18.4		82.50		
	1368	380	3.17	15.2		78.00		
+4°	1206	335	6.00	25.3	37	78.00		
	1350	375	4.45	19.9		82.20		
	1440	400	3.48	17.5		78.00		

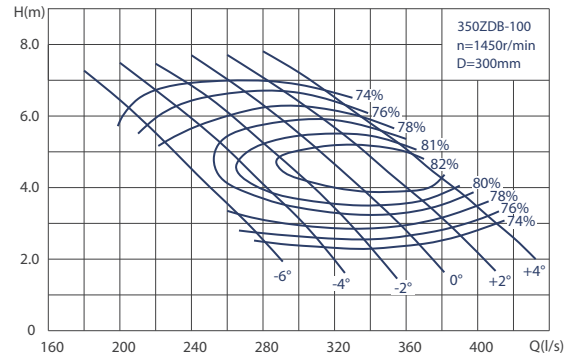

350ZDB-100J

叶片 安装 角度 Installation angle	流量 Capacity		扬程 Head (m)	转速 Speed (r/min)	功率 Power (kW)		效率 Eff. (%)	叶轮 直径 D(mm) Impeller diameter
	(m³/h)	(l/s)			轴功率 Shaft power	电机功率 Motor power		
-6°	548	152	2.42	980	4.7	7.5	76.60	300
	608	169	1.84		3.9		78.20	
	647	180	1.46		3.4		76.60	
-4°	595	165	2.63		5.6	7.5	76.60	
	681	189	1.87		4.4		79.70	
	740	206	1.34		3.5		76.60	
-2°	638	177	2.75		6.2	11	76.60	
	742	206	1.92		4.8		80.30	
	805	224	1.30		3.7		76.60	
0°	685	190	2.85		6.9	11	76.60	
	803	223	1.92		5.2		80.60	
	869	241	1.34		4.1		76.60	
+2°	740	206	2.86	7.5	11	76.60		
	852	237	2.02	5.8		81.10		
	925	257	1.45	4.8		76.60		
+4°	724	201	3.33	9.86	11	70.26		
	860	239	2.43	7.21		83.39		
	950	264	1.76	5.83		83.08		

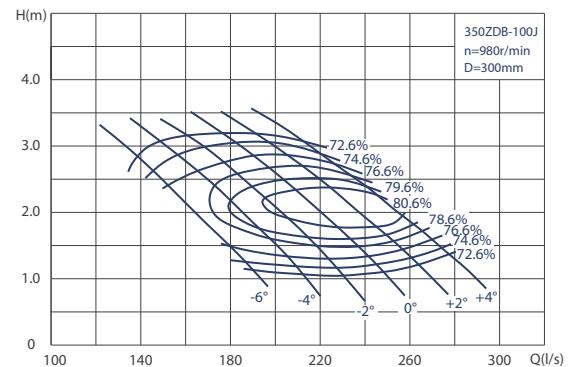

性能参数表及性能曲线

Performance parameter and Performance curve

350ZDB-125

叶片安装角度 Installation angle	流量 Capacity		扬程 Head (m)	转速 Speed (r/min)	功率 Power (kW)		效率 Eff. (%)	叶轮直径 D(mm) Impeller diameter
	(m³/h)	(l/s)			轴功率 Shaft power	电机功率 Motor power		
-4°	745	207	4.56	1450	12.1	15	76.66	300
	914	254	2.84		8.8			
	1004	279	1.72		6.4			
-2°	925	257	4.86	1450	15.7	22	77.76	300
	1091	303	3.19		11.8			
	1188	330	2.12		8.8			
0°	1080	300	5.17	1450	19.9	30	76.50	300
	1260	350	3.60		15.4			
	1368	380	2.59		12.3			
+2°	1202	334	5.46	1450	23.9	30	74.95	300
	1400	389	3.97		18.8			
	1516	421	3.01		15.7			
+4°	1364	379	5.88	1450	31.0	37	70.42	300
	1573	437	4.49		24.4			
	1692	470	3.58		21.1			

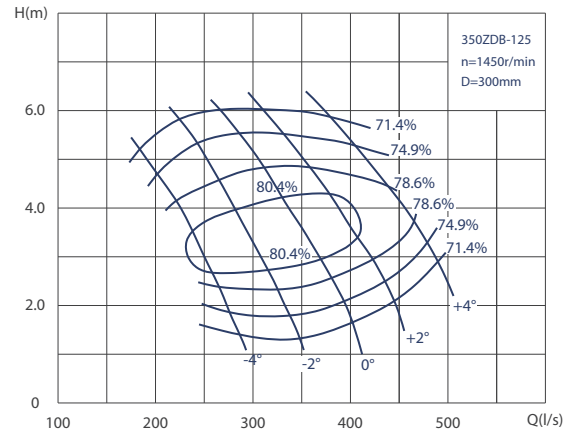

350ZDB-125J

叶片安装角度 Installation angle	流量 Capacity		扬程 Head (m)	转速 Speed (r/min)	功率 Power (kW)		效率 Eff. (%)	叶轮直径 D(mm) Impeller diameter
	(m³/h)	(l/s)			轴功率 Shaft power	电机功率 Motor power		
-4°	504	140	2.07	980	3.7	7.5	76.62	300
	612	170	1.35		2.8			
	695	193	0.66		1.7			
-2°	619	172	2.26	980	4.9	7.5	77.37	300
	724	201	1.56		3.8			
	817	227	0.84		2.5			
0°	713	198	2.45	980	6.3	11	75.70	300
	828	230	1.80		3.0			
	947	263	1.06		3.6			
+2°	788	219	2.61	980	7.6	11	73.97	300
	911	253	2.01		6.2			
	1048	291	1.25		4.6			
+4°	875	243	2.84	980	10.0	11	67.57	300
	1026	285	1.93		6.8			
	1166	324	1.50		6.3			

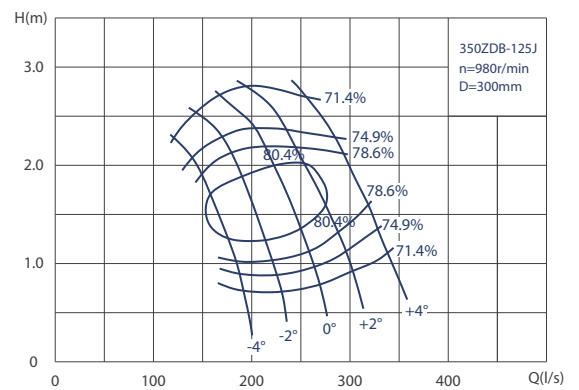

性能参数表及性能曲线

Performance parameter and Performance curve

500ZDB-50

叶片安装角度 Installation angle	流量 Capacity		扬程 Head (m)	转速 Speed (r/min)	功率 Power (kW)		效率 Eff. (%)	叶轮直径 D(mm) Impeller diameter
	(m³/h)	(l/s)			轴功率 Shaft power	电机功率 Motor power		
-4°	1969	547	11.3	980	78.2	90	77.50	450
	2401	667	8.79		70.4		81.70	
	2689	747	5.99		58.6		74.89	
-2°	2099	583	11.4	980	83.5	90	78.02	450
	2556	710	8.90		75.8		81.70	
	2869	797	6.13		63.8		75.09	
0°	2250	625	11.6	980	90.0	90	78.94	450
	2728	758	9.02		82.0		81.70	
	3064	851	6.28		69.4		75.54	
+2°	2419	672	11.7	980	97.1	110	79.37	450
	2902	806	9.15		88.5		81.70	
	3240	900	6.44		76.1		74.65	
+4°	2635	732	12.0	980	107.5	110	80.12	450
	3107	863	9.32		96.5		81.70	
	3420	950	6.60		82.6		74.42	

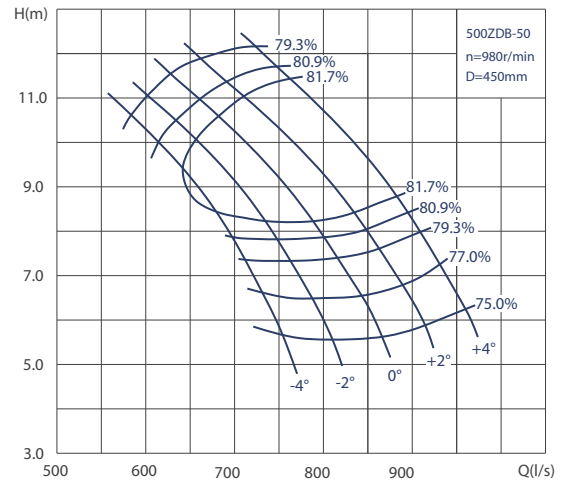

500ZDB-50J

叶片安装角度 Installation angle	流量 Capacity		扬程 Head (m)	转速 Speed (r/min)	功率 Power (kW)		效率 Eff. (%)	叶轮直径 D(mm) Impeller diameter
	(m³/h)	(l/s)			轴功率 Shaft power	电机功率 Motor power		
-4°	1559	433	5.98	730	31.8	37	79.80	450
	1778	494	4.93		29.2		81.70	
	1948	541	3.75		25.2		78.82	
-2°	1656	460	6.04	730	33.9	37	80.24	450
	1890	525	5.01		31.6		81.70	
	2077	577	3.85		27.6		78.84	
0°	1771	492	6.12	730	36.5	37	80.85	450
	2012	559	5.10		34.2		81.70	
	2210	614	3.97		30.2		79.09	
+2°	1897	527	6.21	730	39.5	45	81.19	450
	2135	593	5.20		37.0		81.70	
	2336	649	4.08		32.9		78.94	
+4°	2059	572	6.34	730	43.7	45	81.45	450
	2286	635	5.33		40.6		81.70	
	2473	687	4.21		36.0		78.68	

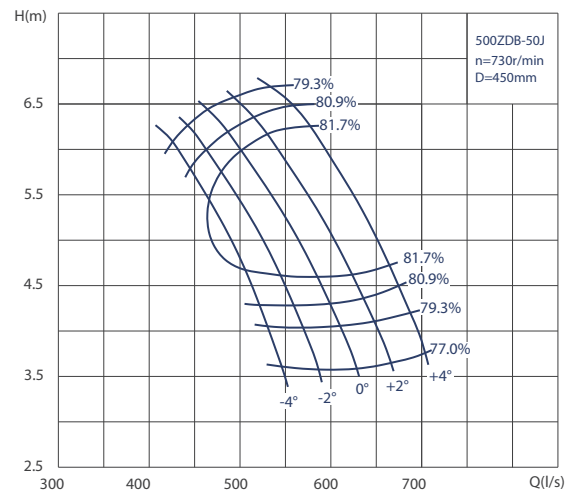

性能参数表及性能曲线

Performance parameter and Performance curve

500ZDB-70

叶片安装角度 Installation angle	流量 Capacity		扬程 Head (m)	转速 Speed (r/min)	功率 Power (kW)		效率 Eff. (%)	叶轮直径 D(mm) Impeller diameter
	(m³/h)	(l/s)			轴功率 Shaft power	电机功率 Motor power		
-6°	2176	605	8.74	980	67.1	75	77.20	450
	2628	730	6.78		58.3		83.20	
	2956	821	3.85		39.2		79.20	
-4°	2258	627	9.13		72.8	90	77.20	
	2694	748	7.19		62.5		84.40	
	3162	878	3.96		43.1		79.20	
-2°	2308	641	9.25		75.3	110	77.20	
	2833	787	7.50		68.4		84.60	
	3326	924	4.11		47.0		79.20	
0°	2365	657	9.56		79.8	132	77.20	
	2948	819	7.83		73.4		85.70	
	3490	969	4.42		53.1		79.20	
+2°	2390	664	9.66	81.5	132	77.20		
	3022	839	7.91	75.7		86.10		
	3613	1004	4.62	57.4		79.20		
+4°	2537	705	9.87	88.4	132	77.20		
	3137	871	8.43	84.6		85.20		
	3794	1054	5.04	65.8		79.20		

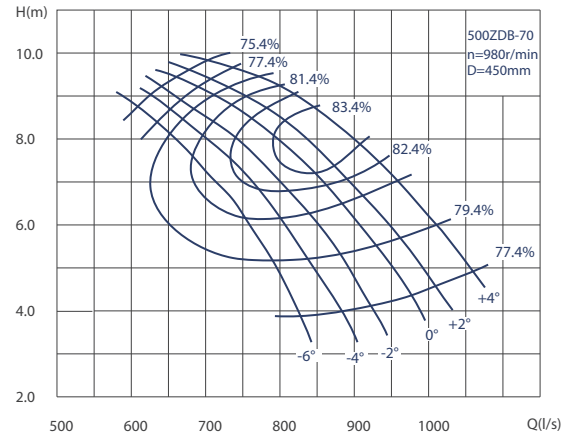

500ZDB-70J

叶片安装角度 Installation angle	流量 Capacity		扬程 Head (m)	转速 Speed (r/min)	功率 Power (kW)		效率 Eff. (%)	叶轮直径 D(mm) Impeller diameter
	(m³/h)	(l/s)			轴功率 Shaft power	电机功率 Motor power		
-6°	1632	453	4.91	735	28.6	37	76.40	450
	1971	547	3.82		24.9		82.40	
	2217	616	2.17		16.7		78.40	
-4°	1694	471	5.13		31.0	45	76.40	
	2020	561	4.05		26.7		83.60	
	2371	659	2.23		18.4		78.40	
-2°	1731	481	5.20		32.1	45	76.40	
	2125	590	4.22		29.2		83.80	
	2494	693	2.31		20.0		78.40	
0°	1774	493	5.38		34.0	45	76.40	
	2211	614	4.41		31.3		84.90	
	2618	727	2.49		22.7		78.40	
+2°	1792	498	5.43	34.7	45	76.40		
	2267	630	4.45	32.2		85.30		
	2710	753	2.60	24.5		78.40		
+4°	1903	529	5.55	37.7	45	76.40		
	2353	654	4.74	36.0		84.40		
	2845	790	2.83	28.0		78.40		

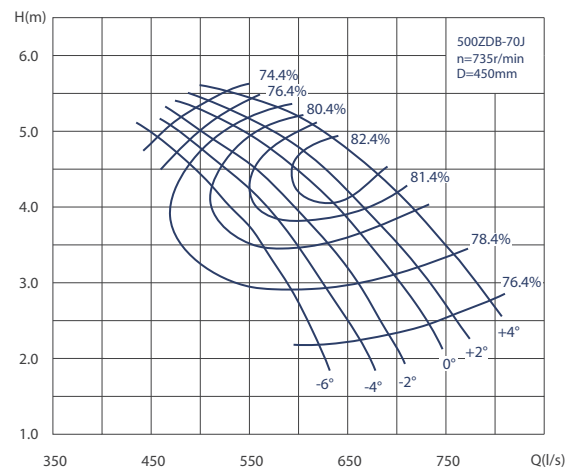

性能参数表及性能曲线

Performance parameter and Performance curve

500ZDB-85

叶片安装角度 Installation angle	流量 Capacity		扬程 Head (m)	转速 Speed (r/min)	功率 Power (kW)		效率 Eff. (%)	叶轮直径 D(mm) Impeller diameter
	(m³/h)	(l/s)			轴功率 Shaft power	电机功率 Motor power		
-4°	1937	538	6.93	980	51.1	55	71.55	450
	2178	605	5.38		39.2			
	2466	685	3.01		27.8			
-2°	2102	584	7.10	980	52.4	75	77.52	450
	2358	655	5.59		46.3			
	2657	738	3.26		31.6			
0°	2257	627	7.27	980	58.0	75	77.01	450
	2520	700	5.78		48.7			
	2812	781	3.47		34.5			
+2°	2362	656	7.39	980	61.3	75	77.52	450
	2664	740	5.97		53.1			
	3006	835	3.75		39.7			
+4°	2520	700	7.58	980	66.2	75	78.57	450
	2837	788	6.21		58.9			
	3186	885	4.03		45.2			

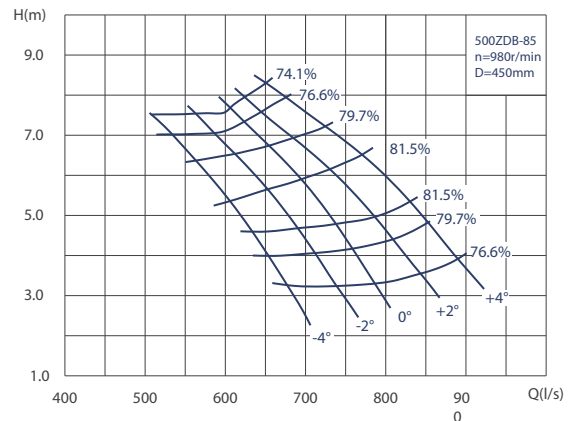

500ZDB-85J

叶片安装角度 Installation angle	流量 Capacity		扬程 Head (m)	转速 Speed (r/min)	功率 Power (kW)		效率 Eff. (%)	叶轮直径 D(mm) Impeller diameter
	(m³/h)	(l/s)			轴功率 Shaft power	电机功率 Motor power		
-4°	1346	374	4.21	730	20.7	30	74.72	450
	1613	448	3.03		16.3			
	1775	493	2.08		12.9			
-2°	1465	407	4.30	730	23.2	37	73.81	450
	1746	485	3.15		18.4			
	1912	531	2.22		14.7			
0°	1559	433	4.38	730	25.6	37	72.71	450
	1681	517	3.27		20.3			
	2030	564	2.35		16.4			
+2°	1627	452	4.44	730	27.1	37	72.56	450
	1969	547	3.38		22.2			
	2160	600	2.51		18.5			
+4°	1721	478	4.53	730	29.2	37	72.82	450
	2092	581	3.52		24.6			
	2290	636	2.67		20.8			

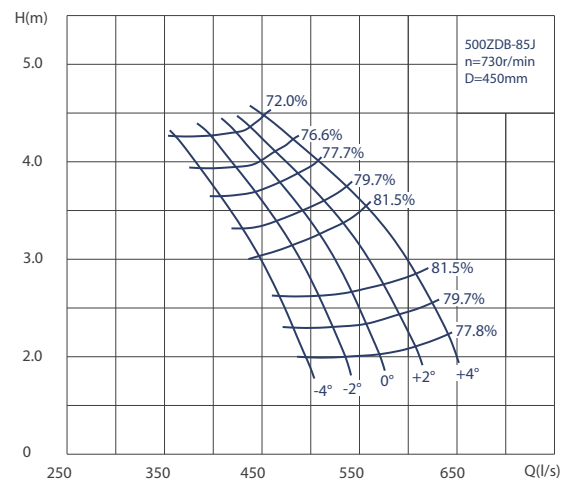

性能参数表及性能曲线

Performance parameter and Performance curve

500ZDB-100

叶片安装角度 Installation angle	流量 Capacity		扬程 Head (m)	转速 Speed (r/min)	功率 Power (kW)		效率 Eff. (%)	叶轮直径 D(mm) Impeller diameter
	(m³/h)	(l/s)			轴功率 Shaft power	电机功率 Motor power		
-6°	1848	513	5.45	980	34.6	45	79.40	450
	2053	570	4.14		28.6		81.00	
	2185	607	3.29		24.7		79.40	
-4°	2008	558	5.91		40.7	55	79.40	
	2299	639	4.21		32.0		82.50	
	2496	693	3.01		25.8		79.40	
-2°	2151	598	6.20		45.8	75	79.40	
	2504	696	4.33		35.6		83.10	
	2718	755	2.93		27.3		79.40	
0°	2312	642	6.42		50.9	75	79.40	
	2710	753	4.32		38.2		83.40	
	2932	814	3.02		30.4		79.40	
+2°	2496	693	6.44	55.2	75	79.40		
	2874	798	4.55	42.5		83.90		
	3121	867	3.26	34.9		79.40		
+4°	2751	764	6.17	58.2	75	79.40		
	3079	855	4.57	45.9		83.60		
	3285	912	3.58	40.4		79.40		

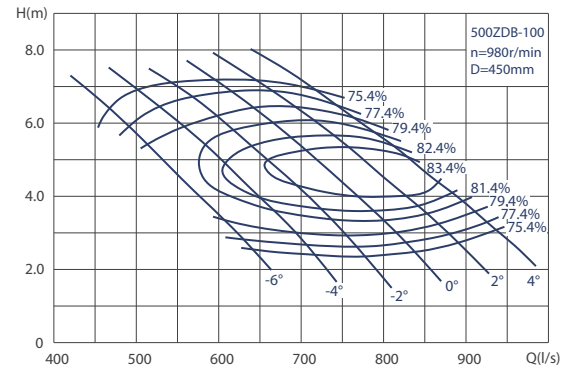

500ZDB-100J

叶片安装角度 Installation angle	流量 Capacity		扬程 Head (m)	转速 Speed (r/min)	功率 Power (kW)		效率 Eff. (%)	叶轮直径 D(mm) Impeller diameter
	(m³/h)	(l/s)			轴功率 Shaft power	电机功率 Motor power		
-6°	1386	385	3.06	735	14.7	22	78.50	450
	1540	428	2.33		12.2		80.10	
	1638	455	1.85		10.5		78.50	
-4°	1506	418	3.32		17.4	30	78.50	
	1724	479	2.37		13.6		81.60	
	1872	520	1.69		11.0		78.50	
-2°	1614	448	3.49		19.5	30	78.50	
	1879	522	2.43		15.1		82.20	
	2039	566	1.65		11.7		78.50	
0°	1734	482	3.61		21.7	30	78.50	
	2033	565	2.43		16.3		82.50	
	2199	611	1.70		13.0		78.50	
+2°	1872	520	3.62	23.5	30	78.50		
	2156	599	2.56	18.1		83.00		
	2340	650	1.83	14.9		78.50		
+4°	2063	573	3.47	24.9	30	78.50		
	2309	642	2.57	19.6		82.70		
	2464	684	2.01	17.2		78.50		

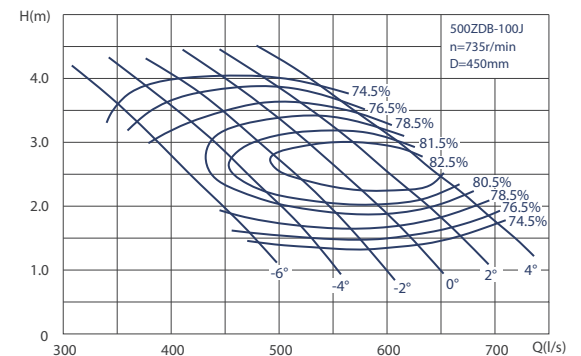

性能参数表及性能曲线

Performance parameter and Performance curve

500ZDB-125

叶片 安装 角度 Installation angle	流量 Capacity		扬程 Head (m)	转速 Speed (r/min)	功率 Power (kW)		效率 Eff. (%)	叶轮 直径 D(mm) Impeller diameter	
	(m³/h)	(l/s)			轴功率 Shaft power	电机功率 Motor power			
-6°	1447	402	3.74	980	18.9	37	77.84	450	
	1681	467	2.56		15.1		77.79		
	1879	522	1.01		6.9		74.59		
-4°	1850	514	4.05		25.3	55	80.52		80.65
	2088	580	2.91		20.3		81.50		
	2376	660	1.41		12.2		75.05		
-2°	2239	622	4.42		33.4	65	80.65		80.65
	2473	687	3.32		27.4		81.50		
	2754	765	1.89		17.7		79.86		
0°	2599	722	4.82		42.6	80	80.00		80.00
	2855	793	3.80		36.2		81.50		
	3121	867	2.42		25.3		81.44		
+2°	2873	798	5.17	51.4	80	78.63	78.63		
	3150	875	4.21	44.3		81.50			
	3477	966	2.88	33.3		82.00			
+4°	3236	899	5.69	67.8	80	73.92	73.92		
	3528	980	4.80	58.3		79.16			
	3848	1069	3.50	45.1		81.25			

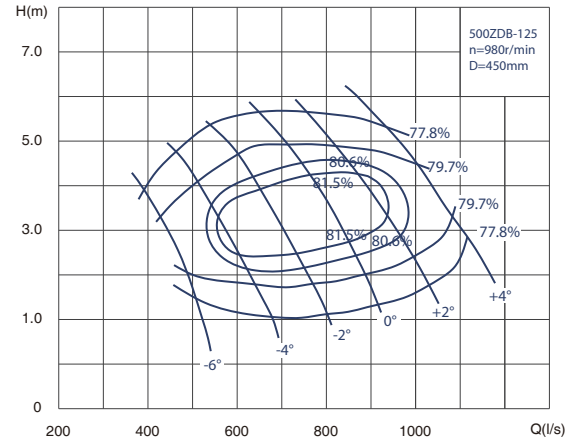

500ZDB-125J

叶片 安装 角度 Installation angle	流量 Capacity		扬程 Head (m)	转速 Speed (r/min)	功率 Power (kW)		效率 Eff. (%)	叶轮 直径 D(mm) Impeller diameter	
	(m³/h)	(l/s)			轴功率 Shaft power	电机功率 Motor power			
-6°	1012	281	2.30	730	8.4	11	75.81	450	
	1231	342	1.50		6.4		79.00		
	1379	383	0.88		4.6		71.90		
-4°	1318	366	2.44		11.0	15	79.33		79.33
	1541	428	1.67		7.9		81.50		
	1688	469	1.07		6.5		75.60		
-2°	1620	450	2.62		14.5	22	79.93		79.93
	1840	511	1.87		11.5		81.50		
	1994	554	1.29		8.8		79.55		
0°	1886	524	2.80		18.2	30	79.04		79.04
	2128	591	2.10		14.9		81.50		
	2304	640	1.55		12.1		80.37		
+2°	2099	583	2.97	21.9	37	77.64	77.64		
	2362	656	2.30	18.1		81.50			
	2552	709	1.79	15.4		80.63			
+4°	2383	662	3.22	28.5	37	73.27	73.27		
	2660	739	2.60	23.6		79.70			
	2851	792	2.11	20.5		79.73			

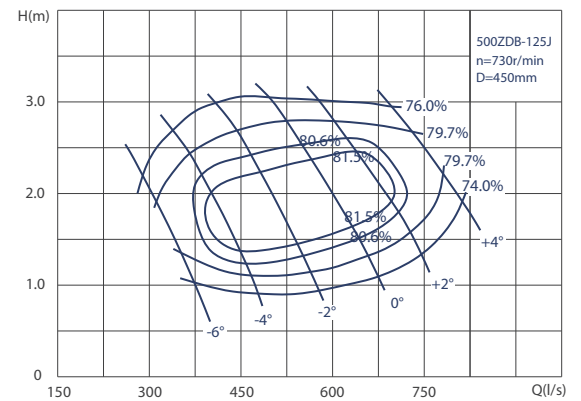

性能参数表及性能曲线

Performance parameter and Performance curve

600ZDB-50

叶片安装角度 Installation angle	流量 Capacity		扬程 Head (m)	转速 Speed (r/min)	功率 Power (kW)		效率 Eff. (%)	叶轮直径 D(mm) Impeller diameter
	(m³/h)	(l/s)			轴功率 Shaft power	电机功率 Motor power		
-4°	2812	781	9.02	730	86.5	110	79.81	550
	3222	895	7.47		79.7		82.20	
	3668	1019	4.86		64.9		74.84	
-2°	2981	828	9.15	730	92.5	110	80.29	550
	3434	954	7.56		86.0		82.20	
	3917	1088	4.98		70.9		74.97	
0°	3179	883	9.30	730	99.6	132	80.82	550
	3884	1079	7.66		98.6		82.20	
	4180	1161	5.12		77.3		75.42	
+2°	3391	942	9.48	730	108.0	132	81.05	550
	3902	1084	7.78		100.6		82.20	
	4421	1228	5.25		84.6		74.71	
+4°	3665	1018	9.73	730	119.5	132	81.23	550
	4180	1161	7.92		109.7		82.20	
	4666	1296	5.40		92.2		74.41	

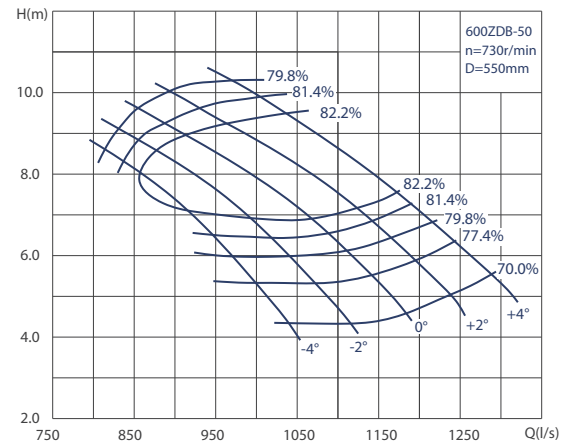

600ZDB-70

叶片安装角度 Installation angle	流量 Capacity		扬程 Head (m)	转速 Speed (r/min)	功率 Power (kW)		效率 Eff. (%)	叶轮直径 D(mm) Impeller diameter
	(m³/h)	(l/s)			轴功率 Shaft power	电机功率 Motor power		
-4°	3920	914	7.42	730	84.8	110	78.45	550
	3715	1032	6.23		76.6		82.32	
	4064	1129	4.72		66.7		78.36	
-2°	3492	970	7.59	730	90.6	110	79.67	550
	3924	1090	6.40		83.2		82.24	
	4298	1194	4.92		72.0		80.02	
0°	3686	1024	7.71	730	96.2	132	80.45	550
	4144	1151	6.58		88.4		84.03	
	4903	1362	5.14		84.3		81.44	
+2°	3895	1082	7.88	730	102.4	132	81.60	550
	4352	1209	6.77		94.7		84.70	
	4774	1326	5.37		85.1		82.03	
+4°	4126	1146	8.07	730	110.4	132	82.14	550
	4597	1277	6.99		103.3		84.70	
	5018	1394	5.62		93.3		82.30	
+6°	4334	1204	8.25	730	118.2	132	82.36	550
	4817	1338	7.21		111.7		84.70	
	5263	1462	5.88		102.3		82.42	

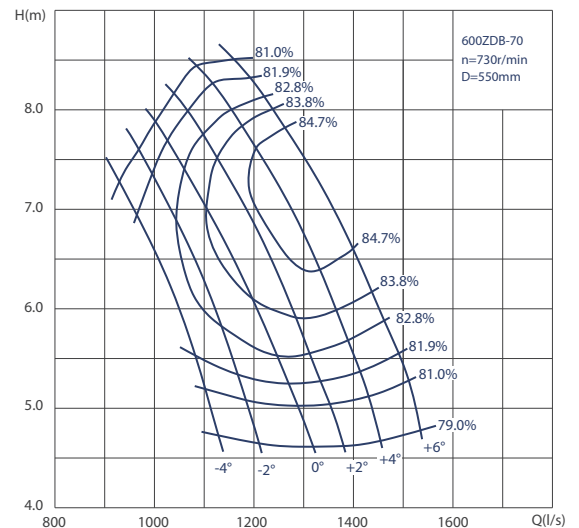

性能参数表及性能曲线

Performance parameter and Performance curve

600ZDB-85

叶片 安装 角度 Installation angle	流量 Capacity		扬程 Head (m)	转速 Speed (r/min)	功率 Power (kW)		效率 Eff. (%)	叶轮 直径 D(mm) Impeller diameter
	(m³/h)	(l/s)			轴功率 Shaft power	电机功率 Motor power		
-4°	2560	711	5.98	730	53.9	75	77.3	550
	2984	829	4.35		43.1		82.0	
	3391	942	2.26		29.2		71.6	
-2°	2783	773	6.12	730	60.5	75	76.6	550
	3229	897	4.53		48.6		82.0	
	3650	1014	2.48		33.6		73.3	
0°	2984	829	6.25	730	67.3	75	75.5	550
	3449	958	4.71		53.9		82.0	
	3866	1074	2.67		37.4		75.2	
+2°	3114	865	6.35	730	70.9	90	76.0	550
	3643	1012	4.87		58.9		82.0	
	4129	1147	2.92		43.1		76.2	
+4°	3316	921	6.50	730	76.1	90	77.1	550
	3877	1077	5.08		65.4		82.0	
	4374	1215	3.16		49.1		76.6	

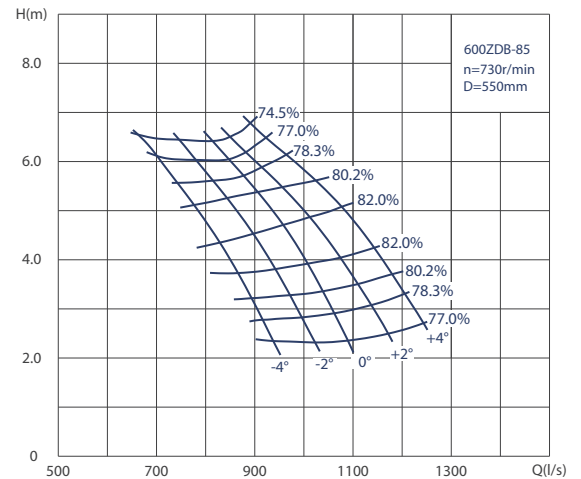

600ZDB-100

叶片 安装 角度 Installation angle	流量 Capacity		扬程 Head (m)	转速 Speed (r/min)	功率 Power (kW)		效率 Eff. (%)	叶轮 直径 D(mm) Impeller diameter
	(m³/h)	(l/s)			轴功率 Shaft power	电机功率 Motor power		
-6°	2530	703	4.58	735	39.6	45	79.80	550
	2811	781	3.48		32.8		81.40	
	2991	831	2.76		28.2		79.80	
-4°	2749	764	4.97	735	46.7	55	79.80	550
	3149	875	3.54		36.6		82.90	
	3418	950	2.53		29.5		79.80	
-2°	2946	818	5.21	735	52.4	75	79.80	550
	3430	953	3.64		40.7		83.50	
	3722	1034	2.46		31.3		79.80	
0°	3166	879	5.40	735	58.4	75	79.80	550
	3711	1031	3.63		43.8		83.80	
	4014	1115	2.54		34.8		79.80	
+2°	3418	950	5.41	735	63.1	75	79.80	550
	3936	1093	3.83		48.7		84.30	
	4273	1187	2.74		40.0		79.80	
+4°	3767	1046	5.18	735	66.6	75	79.80	550
	4217	1171	3.84		52.5		84.00	
	4498	1249	3.01		46.2		79.80	

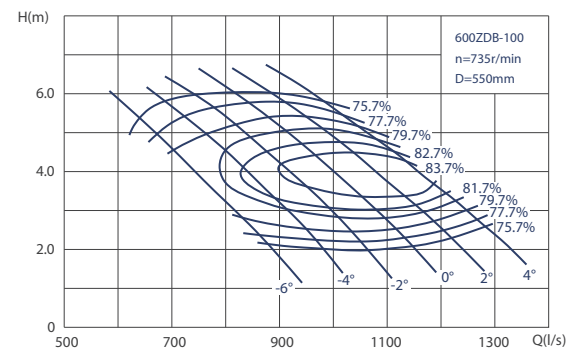

性能参数表及性能曲线

Performance parameter and Performance curve

600ZDB-125

叶片安装角度 Installation angle	流量 Capacity		扬程 Head (m)	转速 Speed (r/min)	功率 Power (kW)		效率 Eff. (%)	叶轮直径 D(mm) Impeller diameter
	(m³/h)	(l/s)			轴功率 Shaft power	电机功率 Motor power		
-6°	1800	500	3.57	730	24.9	30	75.47	550
	2293	637	2.10		18.0		78.24	
	2628	730	0.89		9.0		75.95	
-4°	2329	647	3.82		33.0	37	78.65	
	2833	787	2.42		24.4		82.00	
	3172	881	1.24		15.8		73.41	
-2°	2866	796	4.14		43.7	55	79.32	
	3355	932	2.79		33.3		82.00	
	3719	1033	1.68		23.3		78.17	
0°	3326	924	4.47		55.6	75	77.84	
	3859	1072	3.21		44.0		82.00	
	4259	1183	2.18		33.7		80.20	
+2°	3676	1021	4.75	67.0	110	76.04		
	4244	1179	3.56	53.8		82.00		
	4680	1300	2.61	44.0		80.92		
+4°	4136	1149	5.16	88.1	110	70.65		
	4748	1319	4.08	71.5		79.08		
	5184	1440	3.18	59.7		80.44		

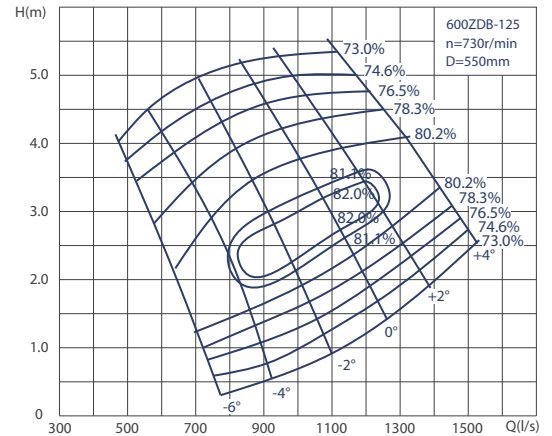

700ZDB-50

叶片安装角度 Installation angle	流量 Capacity		扬程 Head (m)	转速 Speed (r/min)	功率 Power (kW)		效率 Eff. (%)	叶轮直径 D(mm) Impeller diameter
	(m³/h)	(l/s)			轴功率 Shaft power	电机功率 Motor power		
-6°	2982	828	11.04	735	120.3	132	74.60	600
	3766	1046	8.77		109.9		81.90	
	4463	1240	4.80		83.8		69.70	
-4°	3077	855	11.56		129.9	160	74.60	
	4095	1138	9.04		121.4		83.10	
	4847	1346	4.71		89.3		69.70	
-2°	3229	897	11.88		140.1	160	74.60	
	4219	1172	9.31		128.8		83.10	
	5233	1454	4.71		96.4		69.70	
0°	3436	954	11.32		138.0	200	77.70	
	4685	1302	9.35		143.3		83.30	
	5190	1442	4.81		93.64		69.70	
+2°	4027	1119	12.11	171.0	200	77.70		
	4932	1370	9.59	155.1		83.10		
	5992	1665	5.04	118.1		69.70		
+4°	4216	1171	12.33	182.3	200	77.70		
	5187	1441	9.85	167.5		83.10		
	6220	1728	5.47	133.0		69.70		

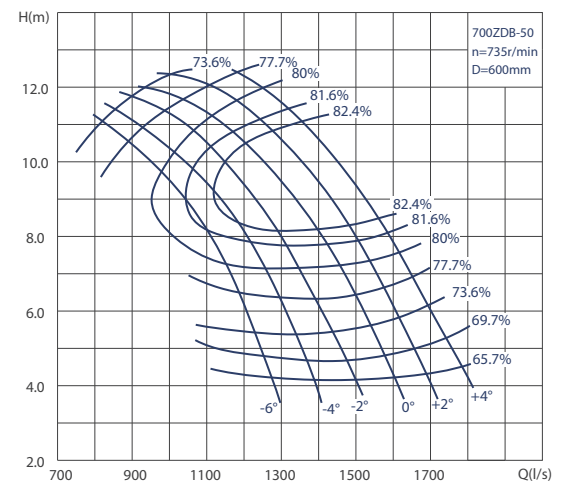

性能参数表及性能曲线

Performance parameter and Performance curve

700ZDB-50J

叶片 安装 角度 Installation angle	流量 Capacity		扬程 Head (m)	转速 Speed (r/min)	功率 Power (kW)		效率 Eff. (%)	叶轮 直径 D(mm) Impeller diameter
	(m³/h)	(l/s)			轴功率 Shaft power	电机功率 Motor power		
-6°	2394	665	7.12	590	62.9	75	73.80	600
	3023	840	5.65		57.4		81.10	
	3583	995	3.09		43.8		68.90	
-4°	2470	686	7.45		67.9	90	73.80	
	3287	913	5.82		63.3		82.30	
	3891	1081	3.03		46.6		68.90	
-2°	2592	720	7.66		73.3	110	73.80	
	3386	941	6.00		67.3		82.30	
	4200	1167	3.03		50.3		68.90	
0°	3004	834	7.55		80.4		76.90	
	3761	1045	6.02		74.8		82.50	
	4536	1260	3.18		57.0		68.90	
+2°	3232	898	7.80	89.3		76.90		
	3959	1100	6.18	81.0		82.30		
	4810	1336	3.25	61.8		68.90		
+4°	3385	940	7.95	95.4		76.90		
	4164	1157	6.35	87.5		82.30		
	4993	1387	3.53	69.7		68.90		

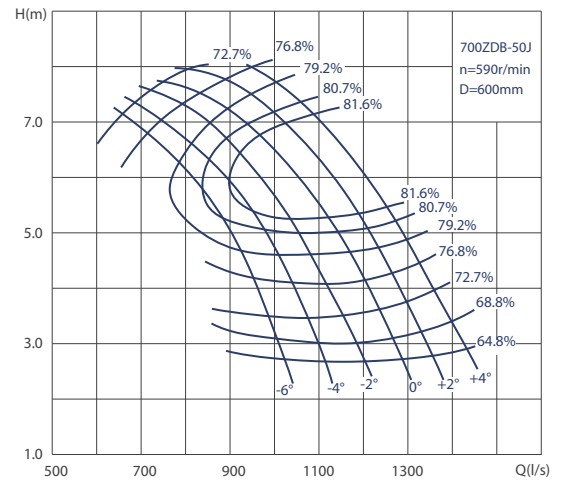

700ZDB-70

叶片 安装 角度 Installation angle	流量 Capacity		扬程 Head (m)	转速 Speed (r/min)	功率 Power (kW)		效率 Eff. (%)	叶轮 直径 D(mm) Impeller diameter
	(m³/h)	(l/s)			轴功率 Shaft power	电机功率 Motor power		
-6°	3869	1075	8.74	735	120.8	132	76.30	600
	4672	1298	6.78		104.9		82.30	
	5256	1460	3.85		70.4		78.30	
-4°	4015	1115	9.13		130.9		76.30	
	4788	1330	7.19		112.4		83.50	
	5620	1561	3.96		77.5		78.30	
-2°	4102	1140	9.25		135.5	160	76.30	
	5036	1399	7.50		123.0		83.70	
	5912	1642	4.11		84.6		78.30	
0°	4204	1168	9.56		143.6		76.30	
	5241	1456	7.83		131.9		84.80	
	6204	1723	4.42		95.4		78.30	
+2°	4248	1180	9.66	146.6		76.30		
	5372	1492	7.91	135.9		85.20		
	6424	1784	4.62	103.3		78.30		
+4°	4511	1253	9.87	159.0	185	76.30		
	5577	1549	8.43	152.0		84.30		
	6745	1874	5.04	118.3		78.30		

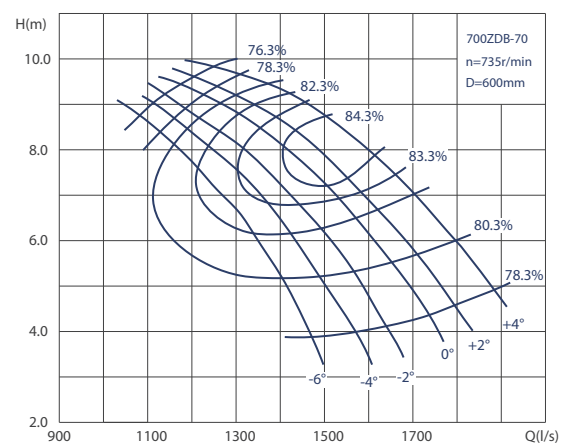

性能参数表及性能曲线

Performance parameter and Performance curve

700ZDB-70J

叶片安装角度 Installation angle	流量 Capacity		扬程 Head (m)	转速 Speed (r/min)	功率 Power (kW)		效率 Eff. (%)	叶轮直径 D(mm) Impeller diameter	
	(m³/h)	(l/s)			轴功率 Shaft power	电机功率 Motor power			
-6°	3105	863	5.63	590	63.0	75	75.60	600	
	3750	1042	4.37		54.7		81.60		
	4219	1172	2.48		36.7		77.60		
-4°	3223	895	5.88		68.3	75	75.60		600
	3844	1068	4.64		58.7		82.80		
	4512	1253	2.55		40.4		77.60		
-2°	3293	915	5.96		70.7	75	75.60		600
	4043	1123	4.83		64.1		83.00		
	4746	1318	2.65		44.2		77.60		
0°	3375	938	6.16		74.9	75	75.60		600
	4207	1169	5.05		68.8		84.10		
	4980	1383	2.85		49.8		77.60		
+2°	3410	947	6.23	76.6	90	75.60	600		
	4312	1198	5.10	70.9		84.50			
	5156	1432	2.98	54.0		77.60			
+4°	3621	1006	6.36	83.0	90	75.60	600		
	4477	1244	5.43	79.2		83.60			
	5414	1504	3.25	61.8		77.60			

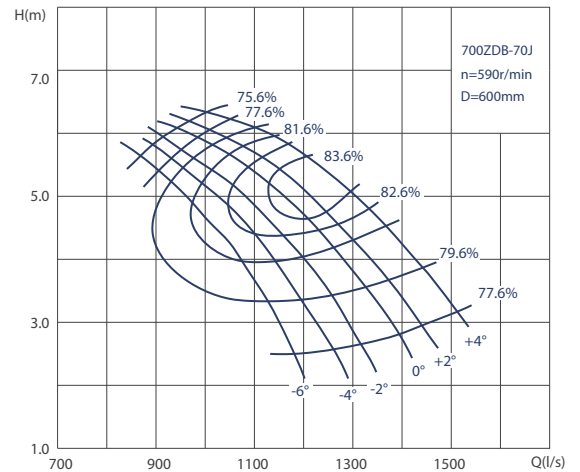

700ZDB-85

叶片安装角度 Installation angle	流量 Capacity		扬程 Head (m)	转速 Speed (r/min)	功率 Power (kW)		效率 Eff. (%)	叶轮直径 D(mm) Impeller diameter	
	(m³/h)	(l/s)			轴功率 Shaft power	电机功率 Motor power			
-4°	4514	1254	7.51	730	114.72	132	80.48	650	
	4914	1365	6.12		99.39		82.40		
	5551	1542	3.36		69.59		72.99		
-2°	4900	1361	7.71		127.73	160	80.54		650
	5324	1479	6.34		111.57		82.40		
	5987	1663	3.65		79.59		74.77		
0°	5260	1461	7.91		140.02	160	80.91		650
	5688	1580	6.56		123.32		82.40		
	6343	1762	3.89		87.11		74.14		
+2°	5522	1534	8.02		148.89	185	81.01		650
	6019	1672	6.78		134.88		82.40		
	6786	1885	4.21		100.27		77.59		
+4°	5904	1640	8.30	163.54	185	81.60	650		
	6419	1783	7.05	149.56		82.40			
	7189	1997	4.52	113.91		77.69			

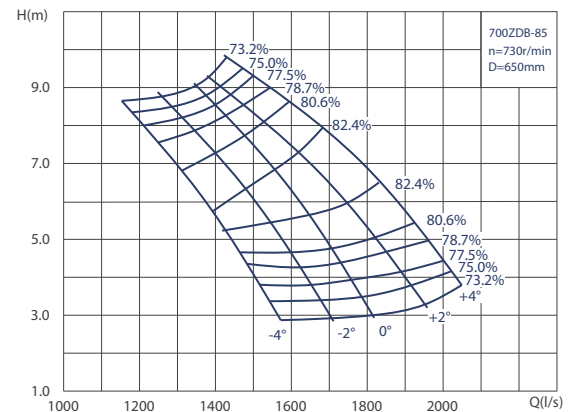

性能参数表及性能曲线

Performance parameter and Performance curve

700ZDB-85J

叶片安装角度 Installation angle	流量 Capacity		扬程 Head (m)	转速 Speed (r/min)	功率 Power (kW)		效率 Eff. (%)	叶轮直径 D(mm) Impeller diameter
	(m³/h)	(l/s)			轴功率 Shaft power	电机功率 Motor power		
-4°	3539	983	5.17	590	63.20	90	78.84	650
	4018	1116	3.86		51.25		82.40	
	4507	1252	2.15		36.26		72.78	
-2°	3852	1070	5.29	590	70.22	90	79.03	650
	4349	1208	4.01		57.63		82.40	
	4871	1353	2.26		40.75		73.57	
0°	4126	1146	5.41	590	77.53	90	78.40	650
	4640	1289	4.15		63.65		82.40	
	5177	1438	2.36		44.52		74.74	
+2°	4338	1205	5.51	590	82.11	110	79.28	650
	4925	1368	4.30		69.99		82.40	
	5562	1545	2.49		50.11		75.27	
+4°	4558	1266	5.56	590	87.55	110	80.21	650
	5245	1457	4.47		77.49		82.40	
	5922	1645	2.62		56.76		74.44	

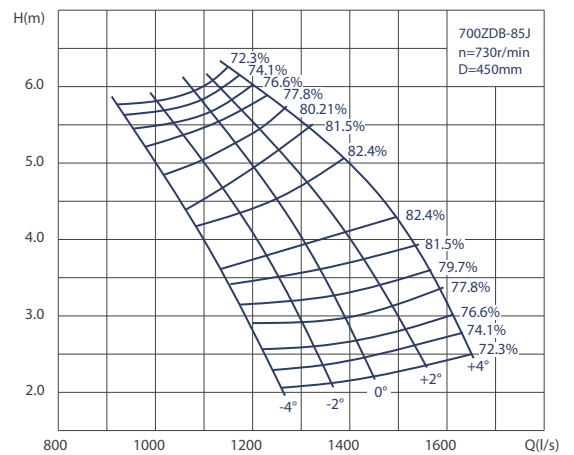

700ZDB-100

叶片安装角度 Installation angle	流量 Capacity		扬程 Head (m)	转速 Speed (r/min)	功率 Power (kW)		效率 Eff. (%)	叶轮直径 D(mm) Impeller diameter
	(m³/h)	(l/s)			轴功率 Shaft power	电机功率 Motor power		
-6°	3285	912	5.45	735	60.7	75	80.30	600
	3650	1014	4.14		50.3		81.90	
	3883	1079	3.29		43.4		80.30	
-4°	3569	992	5.91	735	71.6	75	80.30	600
	4087	1135	4.21		56.2		83.40	
	4438	1233	3.01		45.3		80.30	
-2°	3825	1063	6.20	735	80.5	90	80.30	600
	4453	1237	4.33		62.5		84.00	
	4832	1342	2.93		48.0		80.30	
0°	4109	1142	6.42	735	89.5	90	80.30	600
	4818	1338	4.32		67.3		84.30	
	5212	1448	3.02		53.4		80.30	
+2°	4438	1233	6.44	735	97.0	110	80.30	600
	5110	1419	4.55		74.7		84.80	
	5548	1541	3.26		61.4		80.30	
+4°	4891	1359	6.17	735	102.4	110	80.30	600
	5475	1521	4.57		80.7		84.50	
	5840	1622	3.58		70.9		80.30	

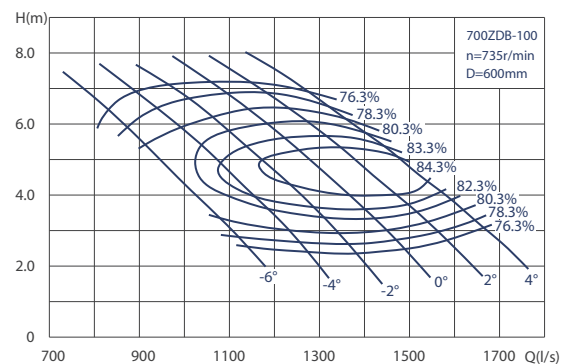

性能参数表及性能曲线

Performance parameter and Performance curve

700ZDB-100J

叶片安装角度 Installation angle	流量 Capacity		扬程 Head (m)	转速 Speed (r/min)	功率 Power (kW)		效率 Eff. (%)	叶轮直径 D(mm) Impeller diameter
	(m³/h)	(l/s)			轴功率 Shaft power	电机功率 Motor power		
-6°	2637	732	3.51	590	31.7	37	79.60	600
	2930	814	2.67		26.3		81.20	
	3117	866	2.12		22.6		79.60	
-4°	2865	796	3.81		37.4	45	79.60	
	3281	911	2.72		29.4		82.70	
	3563	990	1.94		23.7		79.60	
-2°	3070	853	3.99		41.9	55	79.60	
	3574	993	2.79	32.6	83.30			
	3879	1078	1.89	25.1	79.60			
0°	3299	916	4.14	46.8		79.60		
	3867	1074	2.78	35.0		83.60		
	4184	1162	1.95	27.9		79.60		
+2°	3563	990	4.15	50.6		79.60		
	4102	1139	2.93	38.9		84.10		
	4453	1237	2.10	32.0		79.60		
+4°	3926	1091	3.97	53.4		79.60		
	4395	1221	2.95	42.2		83.80		
	4688	1302	2.30	36.9		79.60		

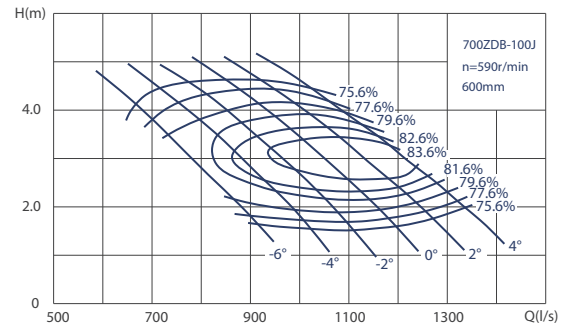

700ZDB-125

叶片安装角度 Installation angle	流量 Capacity		扬程 Head (m)	转速 Speed (r/min)	功率 Power (kW)		效率 Eff. (%)	叶轮直径 D(mm) Impeller diameter
	(m³/h)	(l/s)			轴功率 Shaft power	电机功率 Motor power		
-4°	2890	803	5.07	735	53.5	55	74.70	600
	3621	1006	3.11		37.8		81.20	
	3971	1103	2.10		29.6		76.70	
-2°	3533	981	5.49		70.8	75	74.70	
	4482	1245	3.23		48.3		81.60	
	4861	1350	2.09		36.1		76.70	
0°	4248	1180	5.76		89.3	110	74.70	
	5285	1468	3.56	62.4	82.20			
	5737	1594	2.34	47.7	76.70			
+2°	4920	1367	5.76	103.4		74.70		
	5869	1630	3.68	72.1		81.60		
	6380	1772	2.77	62.8		76.70		
+4°	5956	1655	5.56	120.8		74.70		
	6672	1853	4.07	91.9		80.50		
	6964	1934	3.56	88.1		76.70		

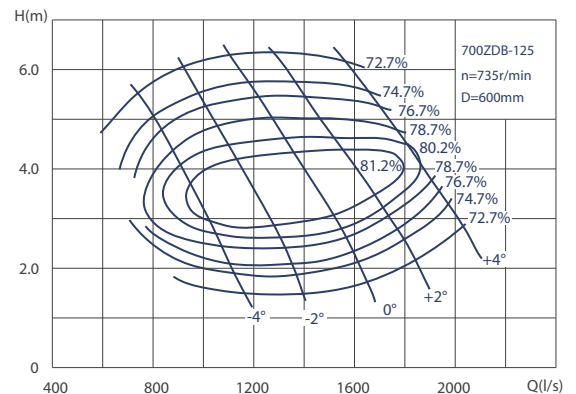

性能参数表及性能曲线

Performance parameter and Performance curve

700ZDB-125J

叶片 安装 角度 Installation angle	流量 Capacity		扬程 Head (m)	转速 Speed (r/min)	功率 Power (kW)		效率 Eff. (%)	叶轮 直径 D(mm) Impeller diameter
	(m³/h)	(l/s)			轴功率 Shaft power	电机功率 Motor power		
-4°	2320	645	3.26	590	27.9	30	73.90	600
	2906	807	2.01		19.8		80.40	
	3187	885	1.35		15.4		75.90	
-2°	2836	788	3.54	590	37.0	45	73.90	600
	3598	999	2.08		25.2		80.80	
	3902	1084	1.34		18.8		75.90	
0°	3410	947	3.71	590	46.7	55	73.90	600
	4242	1178	2.29		32.5		81.40	
	4606	1279	1.51		25.0		75.90	
+2°	3949	1097	3.71	590	54.0	75	73.90	600
	4711	1309	2.37		37.7		80.80	
	5121	1423	1.79		32.9		75.90	
+4°	4781	1328	3.58	590	63.1	75	73.90	600
	5355	1488	2.62		48.0		79.70	
	5590	1553	2.29		46.0		75.90	

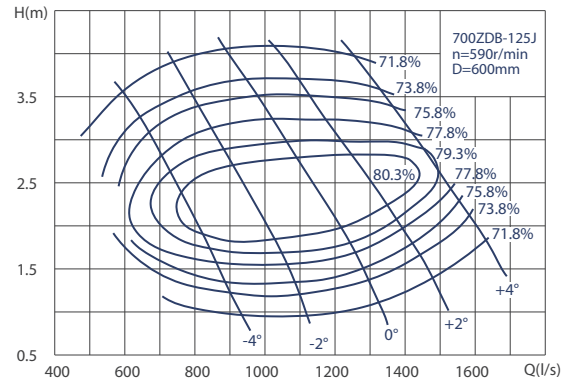

400HDB-40

叶片 安装 角度 Installation angle	流量 Capacity		扬程 Head (m)	转速 Speed (r/min)	功率 Power (kW)		效率 Eff. (%)	叶轮 直径 D(mm) Impeller diameter
	(m³/h)	(l/s)			轴功率 Shaft power	电机功率 Motor power		
-4°	630	175	13.8	1450	29.25	37	80.95	284
	756	210	11.7		28.38		84.89	
	868	241	8.61		24.72		82.28	
-2°	752	209	14.0	1450	34.59	45	82.93	284
	864	240	11.8		32.55		85.30	
	983	273	8.79		28.70		81.95	
0°	799	222	14.9	1450	39.25	55	82.62	284
	925	257	13.0		38.40		85.30	
	1094	304	8.98		32.90		81.36	
+2°	925	257	15.2	1450	45.53	75	84.11	284
	1030	286	13.5		44.38		85.30	
	1217	338	9.21		37.79		80.76	
+4°	1026	285	15.5	1450	51.39	75	84.27	284
	1130	314	13.8		49.80		85.30	
	1328	369	9.44		41.57		82.16	

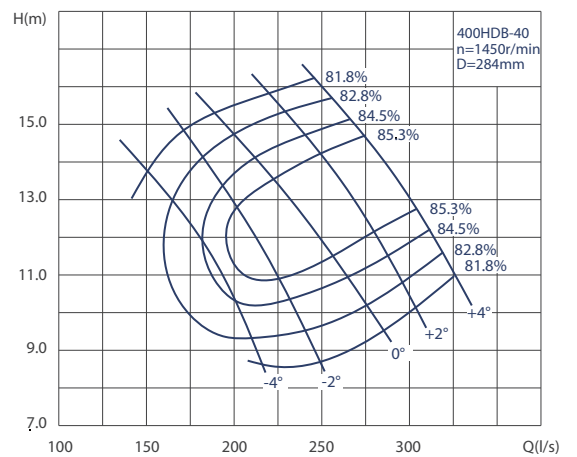

性能参数表及性能曲线

Performance parameter and Performance curve

400HDB-50

叶片安装角度 Installation angle	流量 Capacity		扬程 Head (m)	转速 Speed (r/min)	功率 Power (kW)		效率 Eff. (%)	叶轮直径 D(mm) Impeller diameter
	(m³/h)	(l/s)			轴功率 Shaft power	电机功率 Motor power		
-4°	666	185	14.43	1450	35.51	45	73.7	311
	864	240	10.60		30.64		81.4	
	986	274	6.62		23.87		74.5	
-2°	810	225	14.63		41.91	75	77.0	
	986	274	10.82		35.10		82.8	
	1102	306	6.85		27.62		74.4	
0°	889	247	14.76		45.76	75	78.1	
	1076	299	11.00		38.94		82.8	
	1206	335	7.08		31.13		74.7	
+2°	1008	280	14.98		51.60	75	79.7	
	1206	335	11.28		44.74		82.8	
	1305	375	7.43		36.37		75.1	

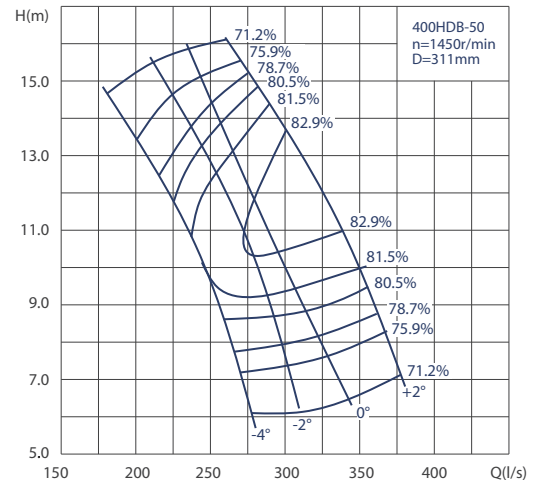

500HDB-40

叶片安装角度 Installation angle	流量 Capacity		扬程 Head (m)	转速 Speed (r/min)	功率 Power (kW)		效率 Eff. (%)	叶轮直径 D(mm) Impeller diameter
	(m³/h)	(l/s)			轴功率 Shaft power	电机功率 Motor power		
-4°	932	259	19.58	1450	61.67	75	80.62	333
	1271	353	15.07		61.14		85.30	
	1310	364	14.14		59.47		84.85	
-2°	1159	322	19.89		76.52	90	82.06	
	1343	373	17.21		73.56		85.55	
	1483	412	14.46		68.83		84.86	
0°	1314	365	20.15		86.33	110	83.52	
	1512	420	17.52		84.28		85.60	
	1656	460	14.82		79.22		84.37	
+2°	1523	423	20.54		100.24	132	84.98	
	1602	445	19.50		99.38		85.60	
	1843	512	15.25		91.91		83.29	
+4°	1688	469	20.89	112.67	132	85.25		
	1764	490	19.86	111.46		85.60		
	2009	558	15.68	104.33		82.22		

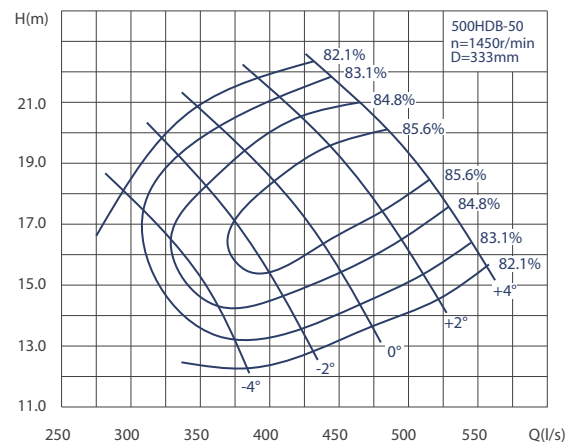

性能参数表及性能曲线

Performance parameter and Performance curve

500HDB-50

叶片 安装 角度 Installation angle	流量 Capacity		扬程 Head (m)	转速 Speed (r/min)	功率 Power (kW)		效率 Eff. (%)	叶轮 直径 D(mm) Impeller diameter
	(m ³ /h)	(l/s)			轴功率 Shaft power	电机功率 Motor power		
-4°	1620	450	11.1	980	60.26	75	81.27	445
	1731	481	9.72		55.68		82.32	
	1948	541	6.36		44.22		76.28	
-2°	1854	515	11.4		69.56	90	82.75	
	1962	373	9.98		63.71		83.70	
	2171	603	6.64		51.27		76.57	
0°	2027	563	11.6		76.59	110	83.60	
	2146	596	10.2		71.21		83.70	
	2376	660	6.92		58.11		77.05	
+2°	2264	629	11.9		87.67		83.70	
	2394	665	10.6		82.57		83.70	
	2650	736	7.34		67.87		78.04	

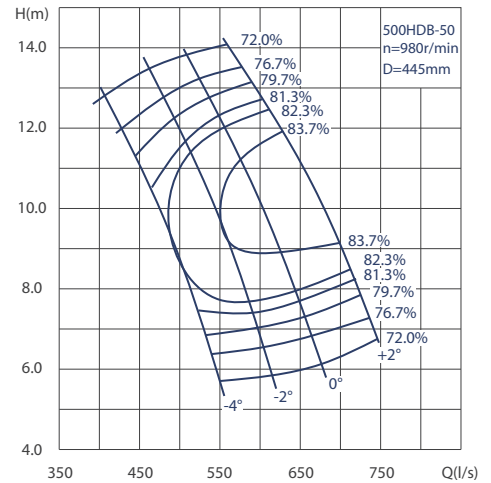

500HDB-50A

叶片 安装 角度 Installation angle	流量 Capacity		扬程 Head (m)	转速 Speed (r/min)	功率 Power (kW)		效率 Eff. (%)	叶轮 直径 D(mm) Impeller diameter
	(m ³ /h)	(l/s)			轴功率 Shaft power	电机功率 Motor power		
-4°	1620	450	10.2	980	55.56	75	81.0	445
	1800	500	8.00		47.59		82.4	
	1973	548	6.08		40.33		81.0	
-2°	1656	460	11.2		62.36	90	81.0	
	1951	542	9.00		57.07		83.8	
	2214	615	6.50		48.38		81.0	
0°	1800	500	11.9		72.02	110	81.0	
	2070	575	10.0		67.27		83.8	
	2412	670	6.70		54.33		81.0	
+2°	1926	535	12.2		79.02		81.0	
	2178	606	10.5		74.44		83.8	
	2563	712	7.00		60.32		81.0	

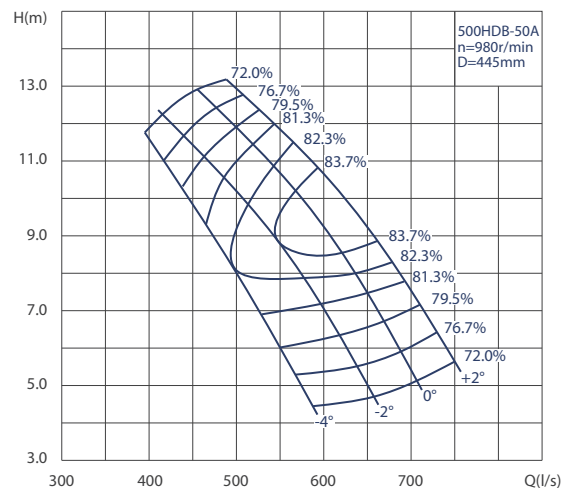

性能参数表及性能曲线

Performance parameter and Performance curve

600HDB-50

叶片安装角度 Installation angle	流量 Capacity		扬程 Head (m)	转速 Speed (r/min)	功率 Power (kW)		效率 Eff. (%)	叶轮直径 D(mm) Impeller diameter
	(m³/h)	(l/s)			轴功率 Shaft power	电机功率 Motor power		
-4°	1602	445	14.3	980	81.0	90	77.0	471
	2088	580	10.2		72.4		82.5	
	2304	640	7.42		60.5		77.0	
-2°	1710	475	15.2		92.0	110	77.0	
	2322	645	11.0		83.8		83.0	
	2574	751	7.5		68.3		77.0	
0°	1847	513	15.9		104.0	132	77.0	
	2459	683	12.0		95.8		83.9	
	2844	790	7.65		77.0		77.0	
+2°	2052	570	16.8		122.0		77.0	
	2808	780	12.0		109.4		83.9	
	3186	885	7.9		89.1		77.0	

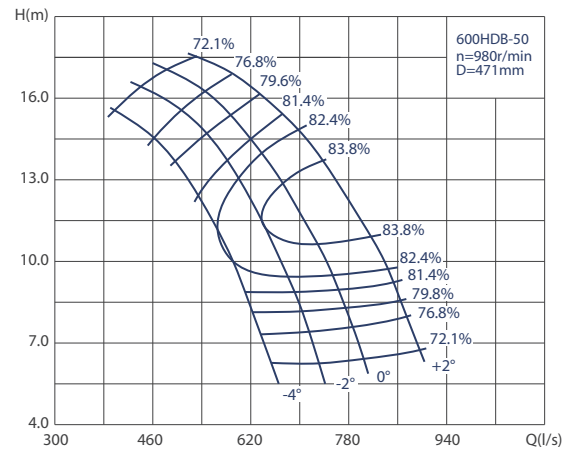

600HDB-50A

叶片安装角度 Installation angle	流量 Capacity		扬程 Head (m)	转速 Speed (r/min)	功率 Power (kW)		效率 Eff. (%)	叶轮直径 D(mm) Impeller diameter
	(m³/h)	(l/s)			轴功率 Shaft power	电机功率 Motor power		
-4°	1602	445	12.9	980	73.09	90	77.0	471
	2106	585	9.00		62.57		82.5	
	2412	670	5.80		49.48		77.0	
-2°	1782	495	13.65		86.03	110	77.0	
	2322	645	10.0		75.37		83.9	
	2718	755	5.90		56.72		77.0	
0°	1926	535	14.2		96.73	132	77.0	
	2520	700	10.5		85.88		83.9	
	2952	820	5.25		54.80		77.0	
+2°	2027	575	14.7		105.40		77.0	
	2700	750	11.0		96.40		83.9	
	3118	880	6.70		73.90		77.0	

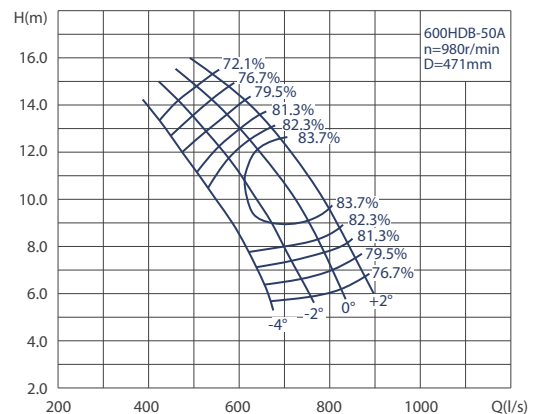

性能参数表及性能曲线

Performance parameter and Performance curve

700HDB-50

叶片安装角度 Installation angle	流量 Capacity		扬程 Head (m)	转速 Speed (r/min)	功率 Power (kW)		效率 Eff. (%)	叶轮直径 D(mm) Impeller diameter
	(m³/h)	(l/s)			轴功率 Shaft power	电机功率 Motor power		
-4°	2531	703	10.30	730	87.02	110	81.58	572
	2725	757	8.96		80.21		82.90	
	3060	850	5.89		63.89		76.82	
-2°	2902	806	10.60		101.03	132	82.91	
	3092	859	9.21		92.01		84.30	
	3420	950	6.16		73.90		77.64	
0°	3164	879	10.8		110.89	160	83.93	
	3366	935	9.42		102.43		84.30	
	3733	1037	6.42		82.77		78.96	
+2°	3535	982	11.1		126.77		84.30	
	3758	1044	9.74		118.26		84.30	
	4165	1157	6.81		98.02		78.81	

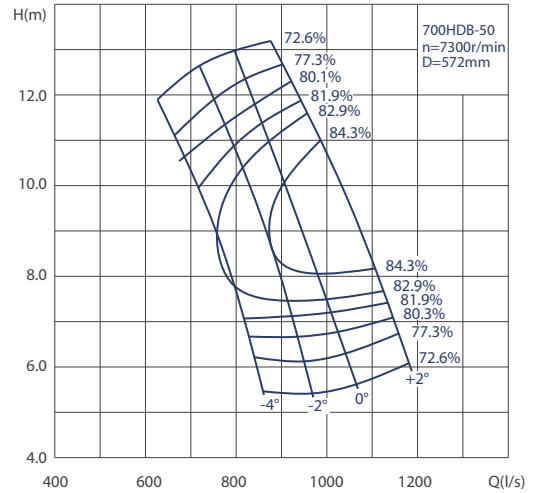

700HDB-50A

叶片安装角度 Installation angle	流量 Capacity		扬程 Head (m)	转速 Speed (r/min)	功率 Power (kW)		效率 Eff. (%)	叶轮直径 D(mm) Impeller diameter
	(m³/h)	(l/s)			轴功率 Shaft power	电机功率 Motor power		
-4°	2124	590	10.5	730	75.92	90	80.0	572
	2794	776	7.30		66.91		83.0	
	3197	888	4.70		50.83		80.5	
-2°	2363	656	11.1		86.74	110	82.3	
	3078	855	8.20		81.34		84.5	
	3604	1001	4.80		58.88		80.0	
0°	2552	709	11.6		100.16	132	80.5	
	3341	928	8.60		92.60		84.5	
	3913	1087	5.10		67.10		81.0	
+2°	2747	763	12.0		111.93		80.2	
	3582	995	9.00		103.90		84.5	
	4201	1167	5.50		76.74		82.0	

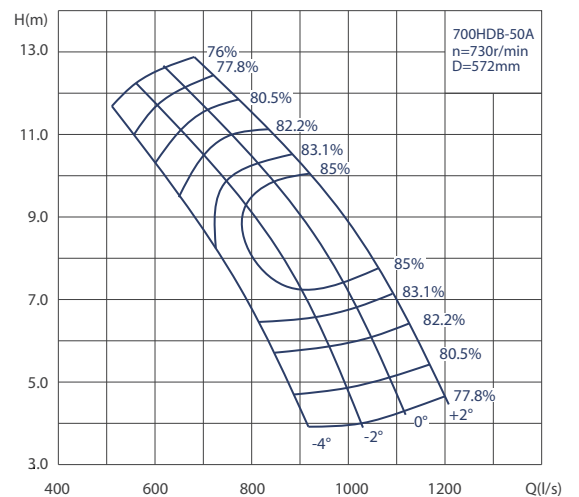

外形及安装尺寸 Outline and Installation Dimensions

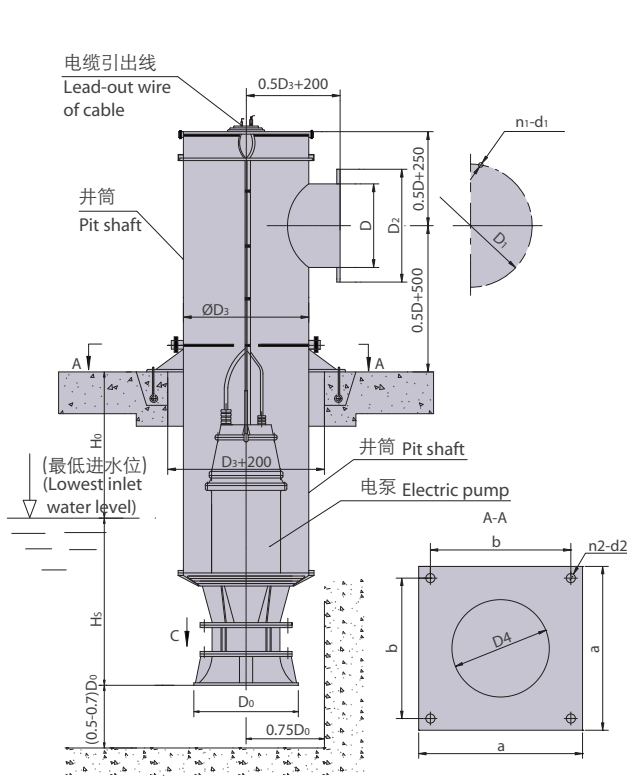

井筒安装外形尺寸(GT)
Outline dimensions of pit shaft equipment(GT)

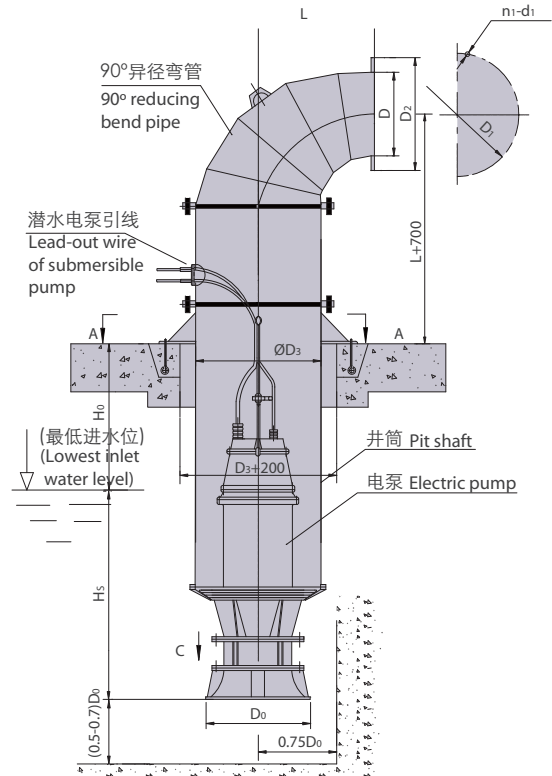

井筒弯管安装外形尺寸(GTW)
Outline dimensions of pit shaft of bend pipe equipment(GTW)

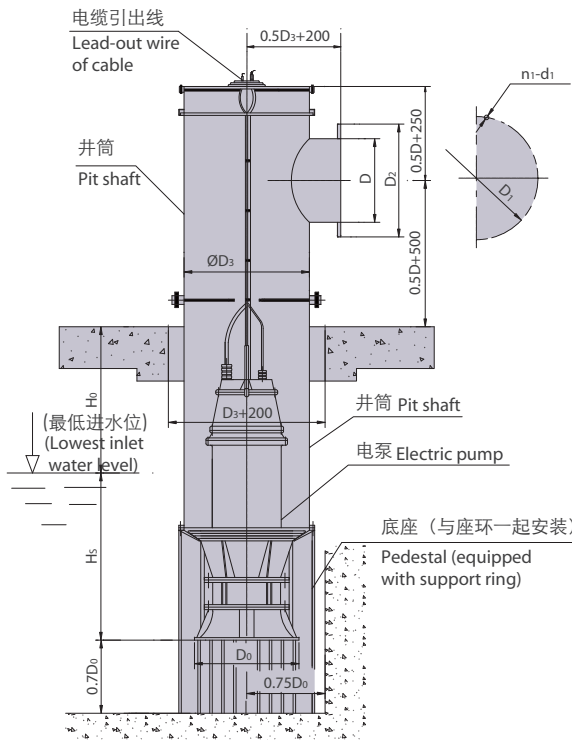

井筒落地安装外形尺寸(GD)
Outline dimensions of ground pit shaft equipment(GD)

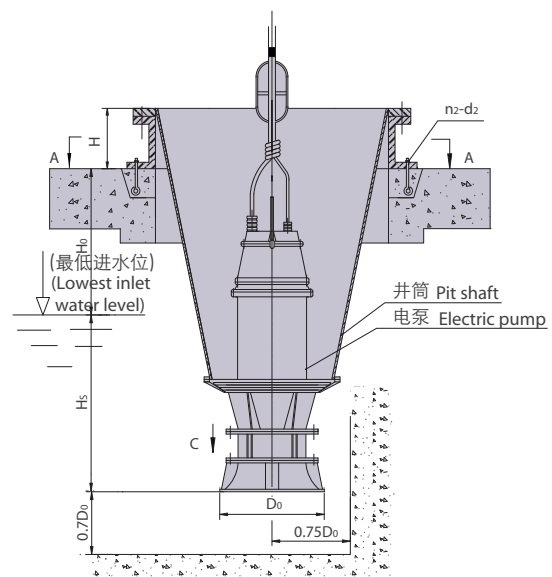

井筒敞开安装外形尺寸(GK)
Outline dimensions of open pit shaft equipment(GK)



外形及安装尺寸表

Outline and Sheet of Equipment Dimensions

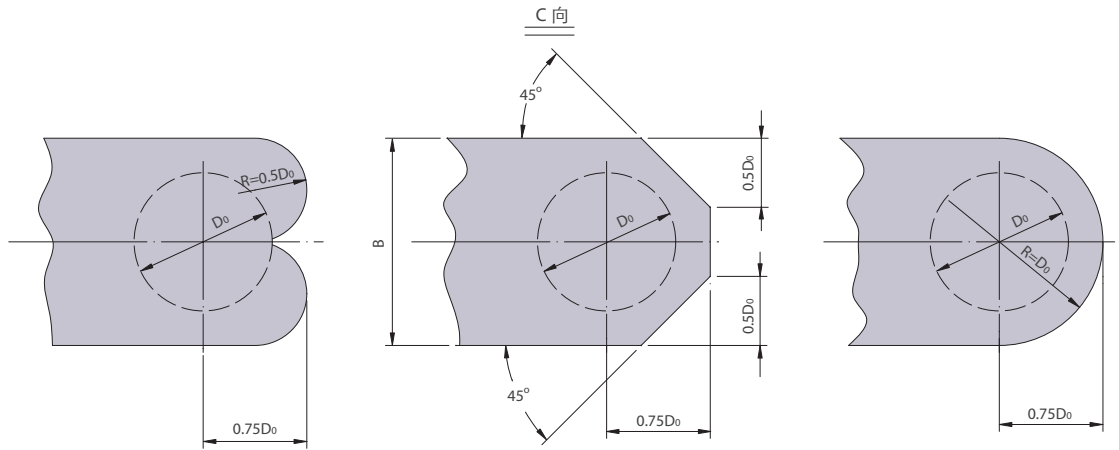

单位(Unit): mm

序号 No.	电泵型号 Pump type	H_s	H_0	D_0	D_3	n_2-d_2	D	D_1	D_2	D_4	a	b	$n1-d1$	H	L	电泵重量 Weight of pump (Kg)	井筒重量 Weight of pit shaft (Kg/m)
1	300ZDB	650		400	500	4-Ø23	300	395	440	512	1050	850	12-Ø23	300	300	360	100
2	350ZDB	800		460	600	4-Ø23	400	495	540	612	1050	850	16-Ø23		545	420	120
3	500ZDB	1000		680	820		600	705	755	832	1400	1200	16-Ø23		695	850	160
4	600ZDB			845	1050	4-Ø34											
5	700ZDB	1700		820	1050		800	920	980	1062	1600	1400	16-Ø23		785	1500	200
6	400HDB	600		500	600	4-Ø23	400	495	540	612	1050	850	16-Ø23		545	560	120
7	500HDB			700	820		600	705	755	712	1400	1200	16-Ø23		695	850	160
8	600HDB	900		830		4-Ø34											
					1020		800	920	980	1032	1600	1400	16-Ø23		785	1800	200
9	700HDB			920													

H_0 由用户定, 合同应注明 H_0 值
 H_0 is specified by user, whose value should be given out in the contract.



轴、混流潜水电泵井筒式安装系统零部件 Spare parts of installation system of pit shaft type axial-flow and mixed-flow submersible electric pump

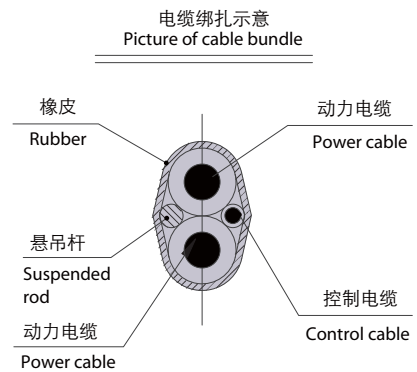
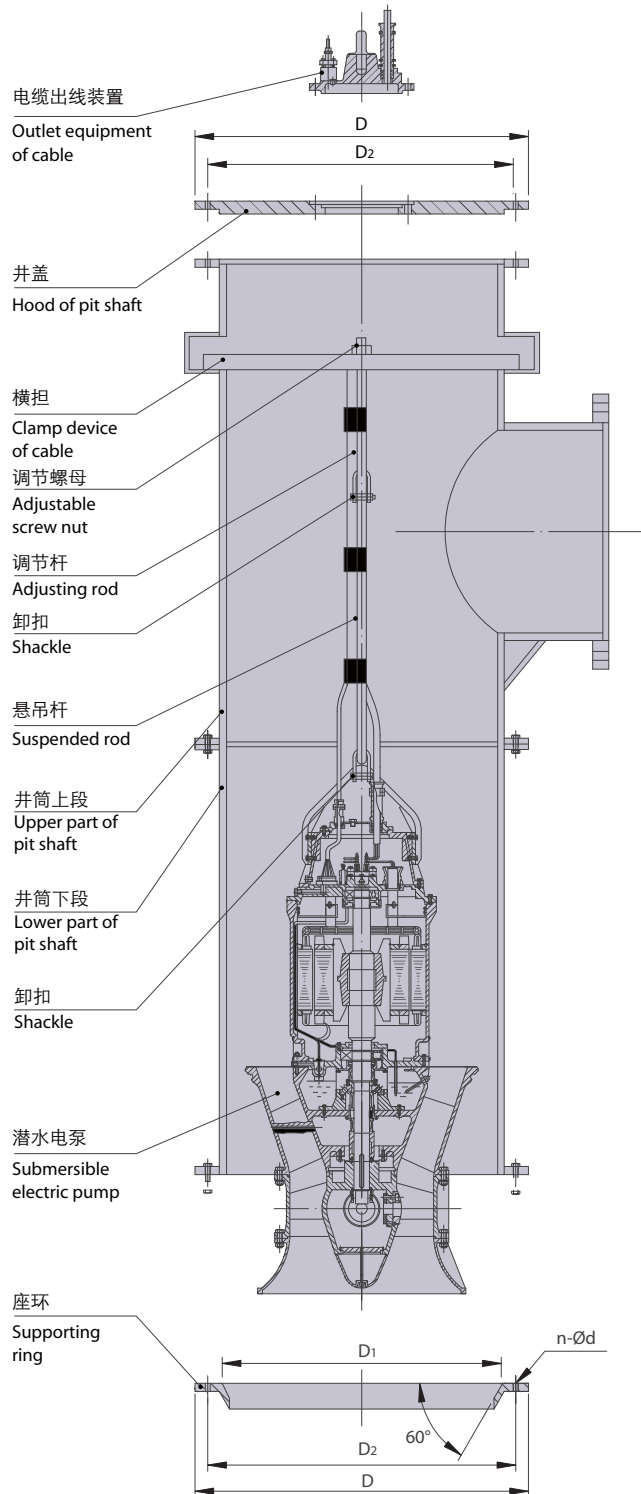

单位: Unit(mm)

型号 Type	D	D ₁	D ₂	n-Ød
300ZDB	645	450	600	8-Ø18
350ZDB	755	520	705	8-Ø18
400HDB	755	600	705	8-Ø18
500Z(H)DB	980	770	920	16-Ø23
600Z(H)DB	1175	940	1120	16-Ø23
700Z(H)DB	1175	970	1120	16-Ø23



轴、混流潜水电泵及安装系统成套范围

Complete set range of axial-flow,mixed-flow submersible electric pump and equipment system

序号 No.	名称 Name	安装形式 Installation formation				备注 Remarks
		井筒式 GT Pit shaft type GT	落地井筒式 GD Ground pit shaft type GD	弯道井筒式 GTW Bend pipe and pit shaft type GTW	开敞式 GK Open type GK	
1	轴、混流潜水电泵 Axial-flow,mixed-flow submersible electric pump	☆	☆	☆	☆	订货时注明泵型、流量、扬程、 电压、安装形式 Indicate pump type,flow rate,lift head, voltage and equipment formation when order goods
2	座环 Supporting ring	☆	☆	☆	☆	HT200 或 Q235-A HT200 or Q235-A
3	钢制井筒 Pit shaft of steel	☆	☆	☆		Q235-A 或 1Cr18NiTi(用户自定) Q235-A or 1Cr18NiTi (determined by user)
4	扩散管 Diverging pipe				☆	
5	过墙管 Wall pipe	☆	☆	☆	☆	
6	排水管 Drain pipe	○	○	○	○	
7	异径弯管 Reducing bend pipe		☆			
8	井盖 Hood of pit shaft	☆	☆			
9	悬吊杆 Suspended rod	☆	☆	☆	☆	
10	电缆夹紧装置 Clamp equipment of cable	☆	☆	☆	☆	
11	泵座 Pump base	○	○	○		HT200 或 Q235-A HT200 or Q235-A
12	电缆出线装置 Outlet equipment of cable	☆	☆	☆	☆	
13	密封垫 Gasket	☆	☆	☆	☆	
14	标准紧固件 Standard fastener	☆	☆	☆	☆	ZnD 或 A2-70 ZnD or A2-70
15	地脚螺栓 Foundation bolt	☆	☆	☆	☆	
16	拍门 Beat gate	○	○	○	○	铸铁拍门或浮箱拍门 Beat gate of cast or beat gate of float tank
17	专用启动柜 Exclusive starting cabinet	○	○	○	○	
18	动力电缆 Power cable	☆	☆	☆	☆	随机电缆长12米或订货时注明长度 Electric cable is 12 meters long or indicate length when place an order
19	控制电缆 Control cable	☆	☆	☆	☆	
20	水位控制器 Water-level controller	○	○	○	○	
21	机械密封 Mechanical seal	○	○	○	○	备品、备件订货时注明数量 Indicate the number of spare parts when place an order
22	O型密封垫 O-ring	○	○	○	○	
23	轴承 Bearing	○	○	○	○	
24	专用工具 Special tool	○	○	○	○	

说明 Note:

☆ 为必购件，是采用该种安装形式所必备的零部件；

is the parts to be purchased parts,which are necessary for this type of installation formation.

○ 为选购件，由用户根据需要决定采购与否及数量。

is the optional parts,which the user determines whether to buy or not and the quantity according to his requirement.



拍门 Beat gate

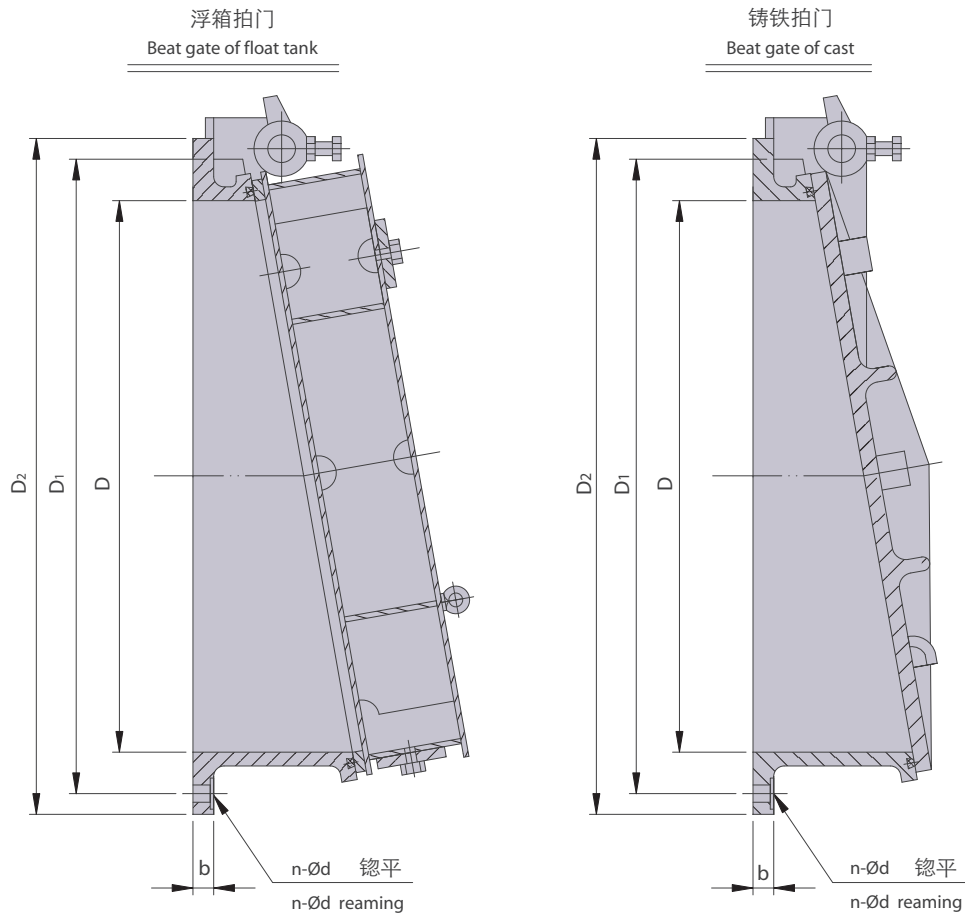

泵出水口径 Diameter of pump outlet	拍门外形尺寸 (mm) External dimension of beat gate (mm)					
	规格 Dimension	D	D ₁	D ₂	b	n-Ød
300	300	300	395	440	20	8-Ø22
350/400	400	400	495	540	22	8-Ø22
500	600	600	705	755	25	10-Ø25
600/700	800	800	920	980	28	12-Ø25

浮箱式门叶在水中比重略大于水的比重，利用浮力增大其开启角度，降低水力损失，提高泵站的装置效率。

Specific gravity of float chamber type gate in water is a little greater than that of water, so use the buoyancy force to increase the open angle, reduce the loss of hydraulic power, and increase the unit efficiency of pump station.



水位控制器 Water-level controller

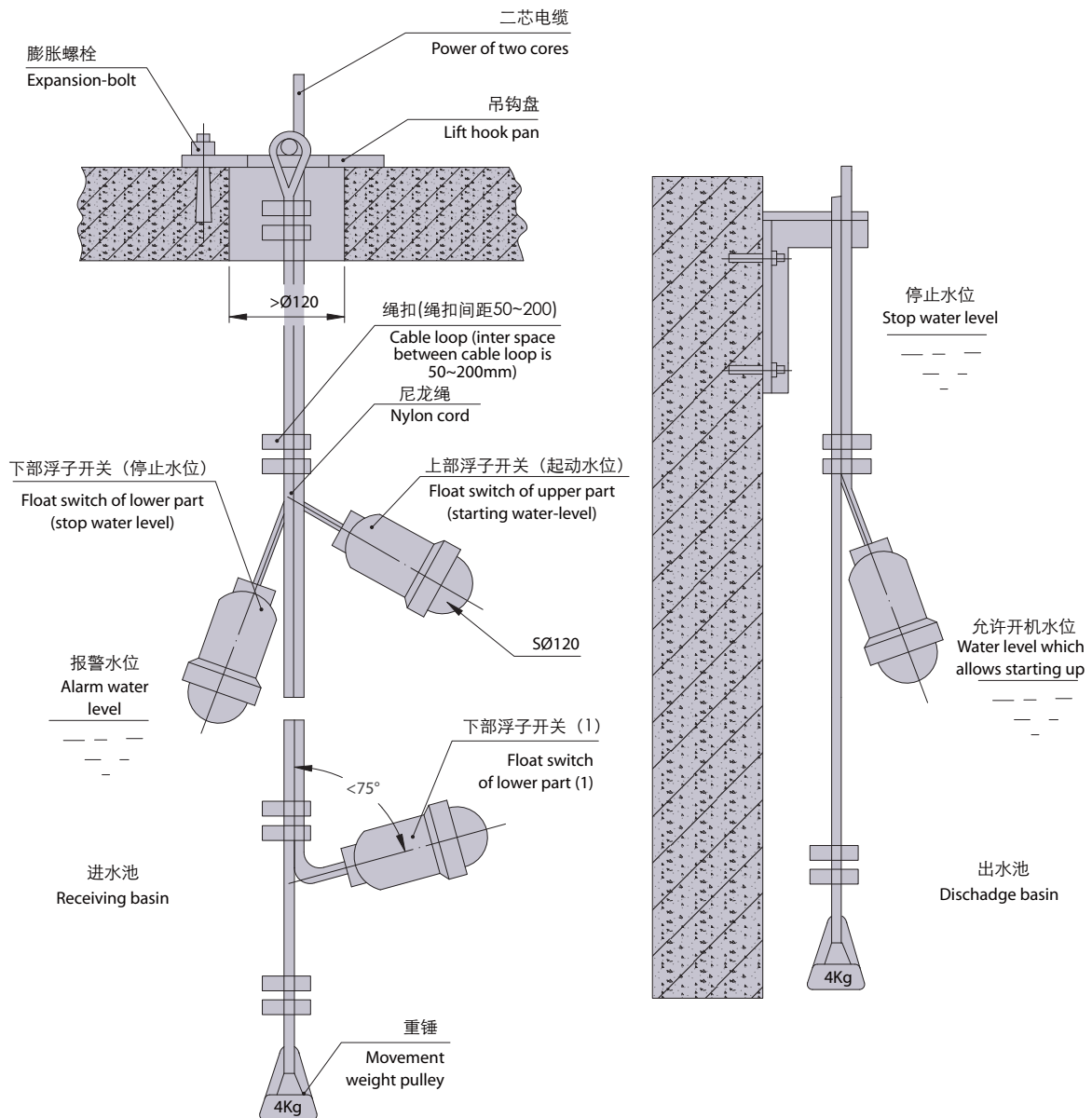

YWK-702浮球式水位控制器，绳扣与浮球间导线长度为0.05-0.2米，根据要求把浮球固定在尼龙绳索上，浮球下垂120°时，电阻为 ∞ ，浮球倒置75°时，电阻为0。

触点容量：220VAC/0.5A

The conducting wire between the water level controller of floating ball type (YWK-702), cable loop and float ball is 0.05-0.2 meter, fix the float ball on the nylon cord according to the requirement. When the float ball sags to form an angle of 120°, the resistance shall be ∞ . When the float ball place upside down forming an angle of 75°, the resistance is zero.

Contact capacity: 220VA/0.5A



机械密封 Mechanical seal

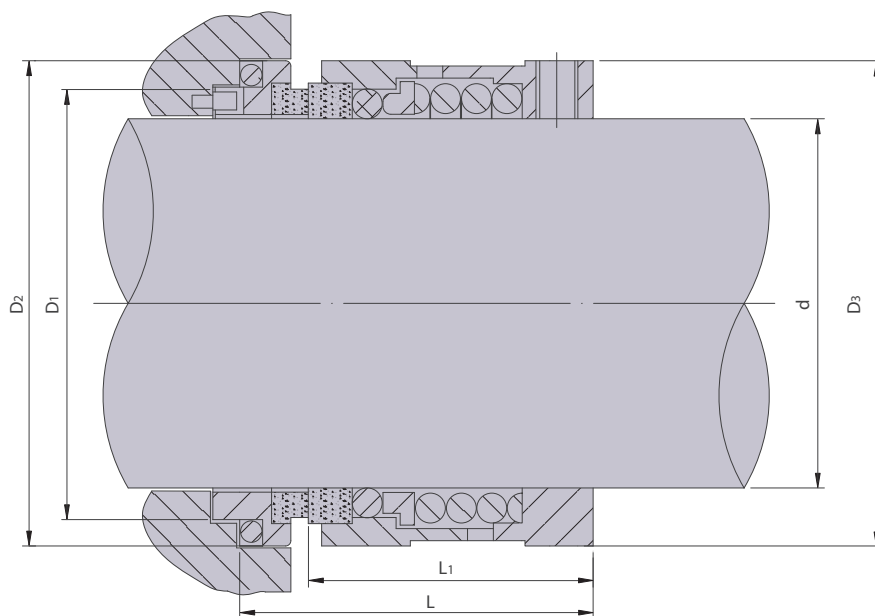

单位: Unit(mm)

机封型号 Type	d	D ₁	D ₂	D ₃	L	L ₁
M524-30	30	40	50	50	60	48
M524-35	35	45	55	55	60	48
M524-40	40	50	60	60	63	50
M524-45	45	55	65	65	63	50
M524-50	50	60	70	70	67	54
M524-55	55	65	75	75	67	54
M524-60	60	70	80	80	67	54
M524-65	65	75	85	85	67	54
M524-70	70	82	92	92	67	54
M524-75	75	88	97	97	67	54
M524-80	80	95	105	105	68	54
M524-85	85	100	110	110	68	54
M524-90	90	105	115	115	73	58
M524-95	95	110	120	120	73	58
M524-100	100	115	125	125	81	66
M524-105	105	120	130	130	81	66
M524-110	110	126	136	136	95	79
M524-120	120	138	150	150	99	79
M524-140	140	158	170	170	101	81
M524-150	150	170	182	182	103	81



潜水电泵内部传感器及功能

Sensor inside submersible electric pump and its functional table

控制电缆 芯线编号 Control cable No. of component wire	1-8	2-8	3-8	5-8	6-7
传感器名称 Name of sensor	绕组温度测温元件 JW6A(135°C) Winding temperature Temperature element JW6A(135°C)	接线盒内漏水电极 Electrode of water leakage in terminal box	电机内漏水电极 Electrode of water leakage in electrical machine	油室内漏水电极 Electrode of water leakage in oil container	轴承温度传感器 ADM590 Bearing temperature sensor ADM590
正常状态电阻值 Value of resistance in normal state	0	断开∞ Cut-out ∞	断开∞ Cut-out ∞	≥33KΩ	正向<80KΩ 反向≈∞ Positive direction<80KΩ, reverse direction≈∞
功能 Function	定子线圈超温保护 温度高于135°C动 作后≥4KΩ When the temperature of stator coil is over than 135°C, circuits open, resistance≥4KΩ	接线盒发生泄漏 电阻R≈0 Terminal box occurs leakage, resistance≈0	电机内腔发生泄漏 电阻R≈0 The inside of electrical machine occurs leakage,electric resistance≈0	水进入油中达10%, 油水混合液阻值 <33KΩ Water in oil reaches 10%,resistance of oil-water mixture <33KΩ	集成块测温元件 ADM-590 传出成正比 的毫安级电量信号 Integrated package temperature element (ADM-590) deliver directly proportionl electric quantity signal of milliampere grading

说明

- 上表中绕组温度测温元件JW6A、轴承温度传感器ADM590是传感器基本布置，亦可按用户要求，绕组温度测温元件选用P.T.C或PT100(RTD)，轴承温度传感器选用PT100(RTD)，但应在合同中注明。传感器在潜水泵内的布置见下表。

Note

- The winding temperature element JW6A, bearing temperature sensor ADM590 in the above table is the basic arrangement of sensor. Also according to the user's requirement, P.T.C or PT100(RTD) is selected as winding temperature element; PT100(RTD) is selected for use of bearing temperature sensor, which should be written in the contract.
- The arrangement of sensors in the submersible electric pump see table below.

潜水电机功率 Submersible motor Power	绕组测温元件 Winding temperature element	接线盒内 漏水传感器 Water leakage sensor in terminal box	电机内 漏水传感器 Water leakage sensor in motor	油室内 漏水传感器 Water leakage sensor in oil chamber	轴承温度 传感器 Bearing temperature sensor
≤15kw	JW6A	-	-	电极 Electrode	-
≥18.5kw	JW6A	电极 Electrode (选配)	电极 Electrode (选配)	电极 Electrode	ADM590 (选配)



内部传感器布置示意图 Drawing of arrangement of inside sensor

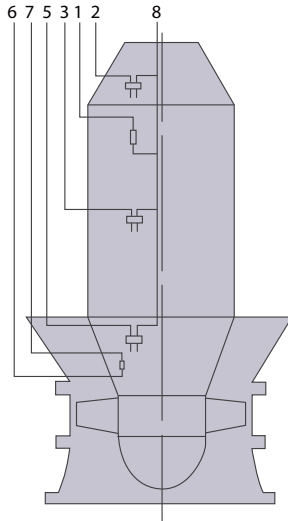

动力电缆

本系列潜水电泵选用的动力电缆，3×70+1×16及以下的规格为矿用橡套软电缆，可供交流660V及以下场所使用，产品标准代号为GB1170-74型号为U或UP型，U型橡套软电缆外层护套材料为氯丁橡胶，线芯绝缘层为天然橡胶，UP型为矿用屏蔽橡套软电缆，线芯绝缘为天然橡胶时，电缆导电线芯长期允许工作温度为+65℃，当电缆在空气中敷设，环境温度为25℃时电缆载流量见表1。3×70+1×16以上的规格选用重型橡套电缆，产品标准代号为GB1169-74，型号为YCW型，当电缆在空气中敷设，环境温度为25℃时电缆载流量见表2。

Power cable

Power cable adopted by this series of submersible electric pump is 3×70+1×16, and the following specification is flexible cable of rubber casing used in mine which can be used in 660V alternating current and in the following occasion. Product standard number is GB1170-74, with U-type and UP-type, the outer retainer of U-type rubber casing flexible cable is neoprene rubber, the insulation of wire core is natural rubber. When UP-type is shield rubber casing flexible cable used in mine and wire core insulation is natural rubber, the wire core of the cable which conducts electricity permits +65℃ for long-term use. When the cable is laid in the air and environmental temperature is 25℃, please see current capacity in table 1. For all the specification over 3×70+1×16, the heavy-duty rubber casing cable is adopted, whose product standard number is GB1169-74 and type is YCW. When the cable is laid in the air and environmental temperature is 25℃, please see current capacity in table 2.

表1 U型、UP型动力电缆载流量
Table 1 Current capacity of U-type and UP-type power cable

芯线×截面 (mm) ² Wire core × cross section(mm) ²	导电线芯结构 根数/单线直径(mm) Core structure of wire number/ single diameter(mm)	电缆最大外径 (mm) Maximum outer diameter of cable(mm)	电缆载流量 (+25℃)(A) Current capacity of cable(+25℃)(A)
3×6+1×6	49/0.39+49/0.39	24.4	46
3×10+1×6	84/0.39+49/0.39	29.2	64
3×16+1×6	84/0.39+49/0.39	32.5	85
3×25+1×10	133/0.49+84/0.39	38.8	113
3×35+1×10	133/0.58+84/0.39	40.3	138
3×50+1×10	133/0.68+84/0.39	45.3	173
3×70+1×16	189/0.68+84/0.49	51.9	215



动力电缆 Power cable

表2 YCW型动力电缆载流量
Table 2 Current capacity of YCW-type power cable

芯线×截面 (mm) ² Wire core × cross section(mm) ²	导电线芯结构 根数/单线直径(mm) Core structure of wire number/ single diameter(mm)	电缆最大外径 (mm) Maximum outer diameter of cable(mm)	电缆载流量 (+25°C)(A) Current capacity of cable(+25°C)(A)
3×16+1×6	84/0.49+49/0.39	28.2	84
3×25+1×10	133/0.49+84/0.39	36.0	116
3×35+1×10	133/0.58+84/0.39	38.6	143
3×50+1×16	133/0.68+84/0.49	45.8	177
3×70+1×25	189/0.68+133/0.49	51.5	224
3×90+1×35	259/0.68+133/0.58	56.8	273
3×120+1×35	259/0.76+133/0.58	60.0	316

当环境温度超过或低于25°C，电缆载流量应作相应调整，即以表1或表2的载流量乘以修正。
When the environmental temperature is over or lower than 25°C, current capacity of cable should be adjusted accordingly, i.e., the current capacity in table 1 and table 2 multiplied by the correction.

系数如下表 Factor as follows

环境温度(°C) Environmental temperature(°C)	15	20	25	30	35
校正系数 Correction factor	1.12	1.06	1.0	0.94	0.87

多根电缆并列敷设时流量的校正系数如下表：

When multiple cable is laid parallel, orrection factor of flow of flow-rate is shown as following

根数 Number	载流量校正系数 Correction factor current capacity		
	1	2	3
配列方式 Method of array	单根 Single	双根并列中心距 S Couplet parallel Center distance S	三根并列中心距 S Three cable is paralleled Center distance S
电缆中心距离 Center distance of cable			
S=d	1.0	0.9	0.85
S=2d	1.0	1.0	0.98
S=3d	1.0	1.0	1.0



控制电缆

本系列潜水电泵选用KJVDR31 型 8×1.5mm²橡套软电缆作为控制电缆，电缆最大外径18mm，适合于500V以下场合使用。

订货须知

- 订货时应注明潜水电泵的名称、型号规格、台数、安装方式、成套范围、起动方式、扬程、流量、功率、电压、水质条件、主要零部件材质，应注意选择的扬程是否包含泵装置全部水头损失的全扬程，如对全扬程估计不准，可注明扬程及安装方式向我公司咨询计算较准确的扬程，并确定潜水电泵的型号规格。
- 泵的最高扬程和最低扬程应参考样本的性能曲线和性能表。如有超过范围情况发生向我公司咨询。
- 在选择安装方式时，对钢制井筒安装方式推荐优先选用样本推荐的尺寸。如需改变表中的尺寸或选用其他安装方式的安装尺寸，请向我公司咨询。
- 订货时请注意样本成套范围。建议必购件应优先选用，选购件为推荐使用。
- 起动方式的选择可选择直接启动、Y-△降压启动、自耦降压启动和软启动。本公司可提供各类起动柜、自动液位控制装置及泵站多泵逻辑顺序控制装置。
- 未注明特殊要求时电泵供电源的频率50HZ、380V。对频率60HZ和特殊电压的产品可在订货时商洽。

Control cable

This series of submersible electric pump adopts KJVDR 31 and 8×1.5mm² rubber casing flexible cable as control cable. Maximum outer diameter of cable is 18mm, which is suitable for usage in the following occasion under 500V.

Ordering instructions

- When placing an order, please give clear indication of name, type model, number, installation method, range in kit form, starting method, lift head, flow-rate, power, voltage, water quality condition, and material of main parts of the submersible electric pump. Attention should be paid if the chosen lifting head is the total head including all water head loss of pump equipment. If you can't estimate the total head correctly, please give clear indication of your lift head and installation direction to our company or consult our company for calculating more precise lift head so as to define specification and model of the submersible electric pump.
- Refer to the performance curve and performance table of catalogue for the highest and lowest lift head of pump. If the lift head is over the range, please consult our company.
- When you are selecting the installation mode, we recommend the dimensions in the catalogue for installation mode of steel pit shaft. If you want to change dimensions of sheet or select other dimensions of installation mode, please consult us.
- When placing an order, please notice complete set range of catalogue. We suggest giving priority to the necessary parts, and the optional parts are recommended to use.
- Starting mode should be direct starting, Y-△ reducing starting, auto reduced-voltage starting and soft start. Our company provides various starting tank, automatic level control equipment and logic sequence controlling device of multiple pump in pump station.
- If there is no special requirement indicated, power frequency and voltage of electric pump is 50HZ, 380V. Please arrange with us for the product of 60HZ and special voltage when placing order.



川源（中国）机械有限公司
GSD Industrial Co., Ltd.

免费咨询电话

400-657-9066

本型录内容如有变更，恕不另行通知。
We reserve the right to change content without notice.

